



SKYWORKS®



# | Aerospace and Defense

 ISOLINK™

 **Trans-Tech™**  
Ceramics and Advanced Materials

# Mission Critical Communications

## | The Sky is Not the Limit

Aerospace and defense industries depend on precision systems operating faultlessly under the most extreme conditions possible. Mission critical functions such as navigation, communication, and radar rely on solutions that work day-in and day-out without fail.

Skyworks' portfolio of RF/microwave products support a broad array of applications including avionics systems, electronic defense and countermeasure platforms, global positioning devices and land mobile radios.

In addition to Skyworks' standard consumer off-the-shelf (COTS) product offering, we offer a broad portfolio of technical ceramics and advanced materials through Trans-Tech, and high reliability ceramic hermetic packaged devices through Isolink, subsidiaries of Skyworks Solutions.



Isolink offers high reliability optocoupler and RF diode, switch and IC products in bare die, conventional and hermetic sealed packaging. Product screenings equivalent to up to JANS level of MIL-PRF-19500 and Class K of MIL-PRF-38534 and MIL-PRF-38535 are also available.



Trans-Tech offers technical ceramics, including RF components, dielectric resonators, ferrites and magnetic materials, as well as advanced materials in technical powder and ingot form.

## | The Right Design Choice Starts Here

Skyworks is continually releasing new products. We invite you to review this brochure as well as our website for a complete list of our solutions from our broad portfolio.

 Skyworks Green™ products are compliant to all applicable materials legislation and are halogen-free. For additional information, please refer to Skyworks Definition of Green™, document number SQ04-0074.



# RF/Analog and High-reliability Solutions



## | Table of Contents

<b>Aerospace and Defense Solutions</b> . . . . .	4
<b>Certifications</b> . . . . .	5
<b>High-reliability Screening Capabilities</b> . . . . .	6
<b>Product Specifications</b>	
Amplification . . . . .	14
Attenuation . . . . .	17
Circulation and Isolation . . . . .	20
DC Blocking and Filtering . . . . .	21
Demodulation . . . . .	22
Filtering . . . . .	23
Mixing . . . . .	25
Optical Coupling . . . . .	28
Power Detection . . . . .	35
Power Management . . . . .	38
Receiver Protection . . . . .	39
Limiter Modules . . . . .	42
Switching . . . . .	42
Tuning . . . . .	48

## Reference Materials

Application Notes . . . . .	50
Published Articles . . . . .	51
Additional Literature . . . . .	51
Designer Kits . . . . .	51
How to Select Diode Packages . . . . .	52
Packaging . . . . .	53
<b>Skyworks' Sales Offices</b> . . . . .	56



Scan to join our customer email program today!



Aerospace



Avionics



Countersurveillance Systems



Homeland Security



Instrumentation



Microwave Subsystems



Global Positioning Systems



Portable Radio Communications



Radar

# Aerospace and Defense Solutions

## The Right Products for Your System Applications

Skyworks and our wholly owned subsidiaries have the RF products you need to speed your design from concept to production. Figure 1 shows Skyworks' transceiver (simplified) block diagram.

### Applications

- Avionics systems
- Electronic Countermeasures (ECM) equipment
- Electronic Warfare (EW)
- Global Positioning System (GPS)
- Improvised Explosive Device (IED)
- Instrumentation
- Joint Tactical Radio System (JRTS)
- Land Mobile Radio (LMR)
- Microwave subsystems
- Software Defined Radio (SDR)
- Surveillance receivers or jammers
- Traffic Collision Avoidance System (TCAS)

### Products

- Amplifiers
- Attenuators
- Ceramic filters
- Circulators and isolators
- Detectors
- Couplers
- Demodulators
- Diodes
- Mixers
- Modulators
- Optocouplers
- Optoisolators
- Power splitters / combiners
- Resonators
- Switches

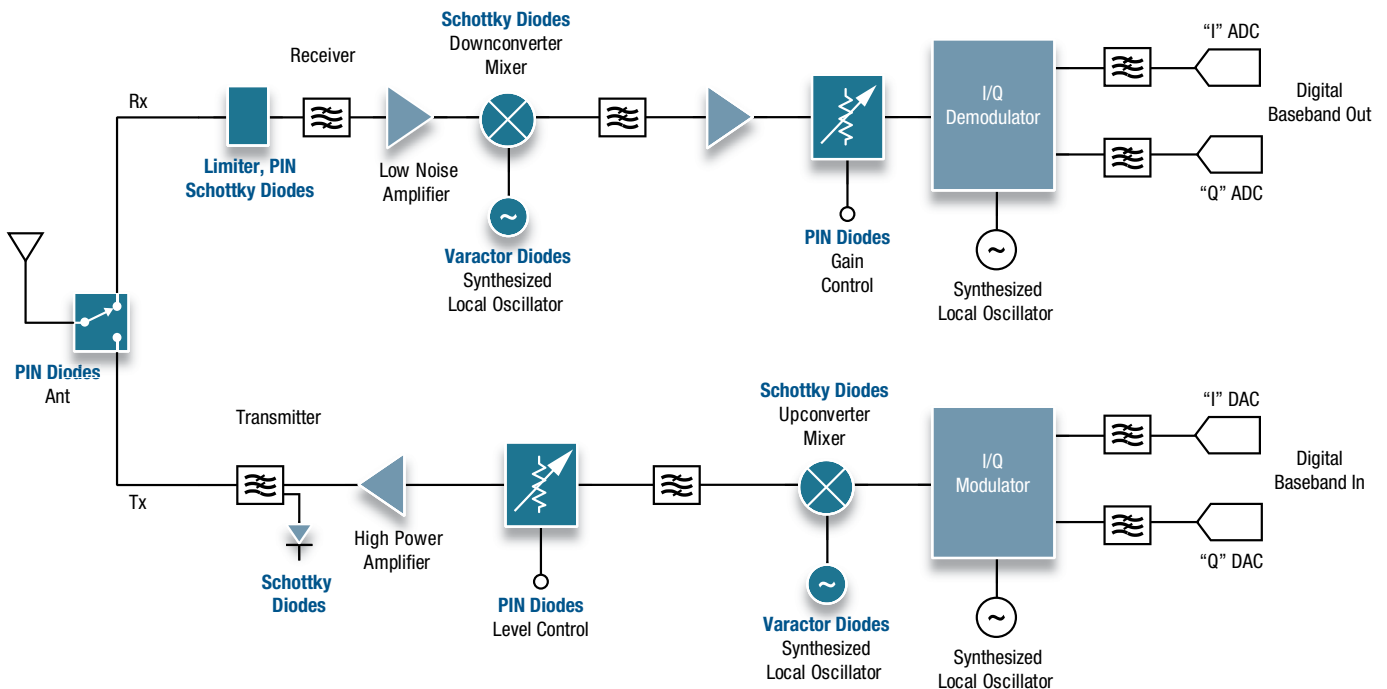

Figure 1. Transceiver (Simplified) Block Diagram



# Certifications

As an industry leader, Skyworks and its wholly owned subsidiaries have demonstrated their quality leadership and strengthened its commitment to customer satisfaction through formal, third-party registration to ISO 9001, ANSI/ESD S.20.20, and ISO 14001. Skyworks' Woburn and Mexicali sites are ISO/TS 16949 certified.

Company	ISO 9001	ANSI/ESD S.20.20	ISO 14001	ISO/TS 16949 <sup>1</sup>
Skyworks Solutions, Inc.	•	•	•	•
Trans-Tech, Inc. <sup>2</sup>	•		•	
Isolink <sup>2</sup>	•			

## ISO 9001

ISO 9001 is an internationally recognized Quality Management System standard that promotes customer satisfaction through continual improvement of the system's effectiveness. ISO 9001 provides a model for a Quality Management System which focuses on the effectiveness of the processes in a business to achieve desired results. The standard promotes the adoption of a process approach emphasizing the requirements, added value, process performance and effectiveness, and continual improvement through objective measurements.

## ANSI/ESD S.20.20

ANSI/ESD S.20.20 is a standard for the Development of an Electrostatic Discharge Control Program for Protection of Electrical and Electronic Parts, Assemblies and Equipment. The standard covers the requirements necessary to design, establish, implement, and maintain an Electrostatic Discharge (ESD) Control Program.

## ISO/TS 16949

One of the major challenges facing today's manufacturers is that, even though there is a low failure probability for each individual component, the total failure probability for all parts combined may reach unacceptable levels. The ISO/TS 16949 standard answers this challenge by defining requirements focused on continual improvement, and the understanding of process interaction. It also creates an implementation framework for customer specific requirements, and includes clear requirements for development processes and techniques to prevent problems in the earliest possible stage of product development.

Jointly developed by International Automotive Task Force (IATF), ISO/TS 16949 is the automotive industry's international quality management system standard intended to answer the need for global consistency, continual improvement, and increased customer satisfaction. It is approved and released by the International Organization for Standardization (ISO).

## ISO 14001:2004

As an industry leader, Skyworks is committed to the protection and preservation of the environment in all its business operations. We understand that our actions today can have environmental impacts tomorrow. Improvements at our facility will affect our customers and ultimately consumers. To this end, we have an established ISO 14001 certified Environment Management System by which we operate. We build products in consideration of regulatory and industry requirements, such as Restriction of Hazardous Substances Derivative (RoHS), and offer lead (Pb)-free, RoHS-compliant, and Green™ solutions to meet the needs of our customers in today's environmentally-conscious market.

1. Woburn, MA and Mexicali, B.C. sites

2. Wholly owned subsidiary of Skyworks Solutions, Inc.

# High-reliability Screening Capabilities

When requested, Isolink will perform up to JANS level high-reliability testing on ceramic packaged diode devices in accordance with MIL-PRF-19500, and Element Evaluation on unpackaged dice and beam-lead diode devices in accordance with MIL-PRF-38534. Isolink also offers lot approval services for sensitive circuits. The table below shows screening requirements for ceramic packaged diode devices.

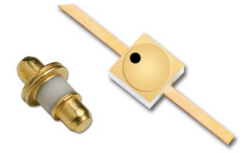

## Screening Requirements for Ceramic Packaged Diode Devices

Screening Requirement in Accordance with Table E-IV-MIL-PRF-19500

Step	Process	Conditions	Comments	JANS	JANTXV	JANTX
1	Pre-Cap Inspection	MIL-STD-750 – Method 2070		•	•	
2	High-Temperature Bake	MIL-STD-750 – Method 1032	t = 24 Hours	•	•	•
3	Temperature Cycling	MIL-STD-750 – Method 1051	20 Cycles. Condition C	•	•	•
4	Constant Acceleration	MIL-STD-750 – Method 2006	Condition A Y1 Axis Only	•	•	•
5	PIND	MIL-STD-750 – Method 2052	Condition A	•		
6	Initial Electrical Test		Serialize, Read and Record	•	•	•
7	High-Temperature Reverse Bias	MIL-STD-750 – Method 1038	Condition A, t = 48 Hours	•	•	•
8	Interim Electricals		Read and Record	•	•	•
9	Burn-in	MIL-STD-750 – Method 1038	Condition B, (JANS t = 240 Hours, JANTX & JANTXV t = 160 Hours)	•	•	•
10	Final Electrical Test		Group A, Subgroup 2 and 3. Read and Record	•	•	•
11	Delta Calculation		Compare Interim Test to Final Test	•	•	•
12	PDA		Percent Defective Allowable (JANS = 5% Max.; JANTX and JANTXV = 10% Max.)	•	•	•
13	Fine Leak	MIL-STD-750 – Method 1071	Condition H	•	•	•
14	Gross Leak	MIL-STD-750 – Method 1071	Condition C	•	•	•
15	X-ray	MIL-STD-750 – Method 2076		•		
16	External Visual Inspection	MIL-STD-750 – Method 2071		•	•	•
17	Case Isolation	Not Applicable				

## Screening Requirements for Ceramic Packaged Diode Devices (Continued)

### Group A Inspection in Accordance with Table E-IV-MIL-PRF-19500

Step	Process	Conditions	Comments	JANS	JANTXV	JANTX
Subgroup 1						
1	Visual and Mechanical Inspection	MIL-STD-750 – Method 2071	Sample Size: JANS = 15(0), JANTX and JANTXV = 45(0)	•	•	•
Subgroup 2						
1	Electrical Testing		DC (Static) @ $T_A = 25\text{ }^\circ\text{C}$ , Sample Size = 116(0)	•	•	•
Subgroup 3						
1	Electrical Testing		DC (Static) @ Min. and Max. Operating Temp., Sample Size = 116(0)	•	•	•
Subgroup 4						
1	Electrical Testing		Dynamic @ $T_A = 25\text{ }^\circ\text{C}$ , Sample Size = 116(0)	•	•	•
Subgroup 5 – Not Applicable						
Subgroup 6 – Not Applicable						
Subgroup 7 – Not Applicable						

### Group B Inspection for JANS Devices in Accordance with Table E-VIA-MIL-PRF-19500

Step	Process	Conditions	Comments	JANS	JANTXV	JANTX
Subgroup 1						
			Large Lot = 22(0), Small Lot = 8(0)			
1	Physical Dimensions	MIL-STD-750 – Method 2066	Sample Size	•		
Subgroup 2						
1	Solderability	MIL-STD-750 – Method 2026	Sample Size – Large Lot = 15(0) Leads, Small Lot = 6(0) Leads	•		
2	Resistance to Solvents	MIL-STD-750 – Method 1022	Sample Size – Large Lot = 15(0) Devices, Small Lot = 6(0) Devices	•		
Subgroup 3						
			Large Lot = 22(0), Small Lot = 6(0)			
1	Temperature Cycling	MIL-STD-750 – Method 1051	100 Cycles. Condition C, Sample Size	•		
2	Fine Leak	MIL-STD-750 – Method 1071	Condition H, Sample Size	•		
3	Gross Leak	MIL-STD-750 – Method 1071	Condition C, Sample Size	•		
4	Electrical Testing		DC @ $T_A = 25\text{ }^\circ\text{C}$ , Sample Size	•		
5	Decap Internal Visual	MIL-STD-750 – Method 2075	Sample Size = 6(0)	•		
6	Bond Strength	MIL-STD-750 – Method 2037	The same number of devices used for bond strength will also be used for die shear.	•		
7	Die Shear	MIL-STD-750 – Method 2017	The same number of devices used for bond strength will also be used for die shear.	•		
Subgroup 4						
			Large Lot = 22(0), Small Lot = 12(0)			
1	Intermittent Operation Life	MIL-STD-750 – Method 1037	2,000 Cycles. Condition D, Sample Size	•		
2	Electrical Testing		DC @ $T_A = 25\text{ }^\circ\text{C}$ , Sample Size	•		

## Screening Requirements for Ceramic Packaged Diode Devices (Continued)

### Group B Inspection for JANS Devices in Accordance with Table E-VIA-MIL-PRF-19500 (Continued)

Step	Process	Conditions	Comments	JANS	JANTXV	JANTX
Subgroup 5			Large Lot = 22(0), Small Lot = 12(0)			
1	Accelerated Steady-State Operation Life	MIL-STD-750 – Method 1027	1,000 Hours Sample Size	•		
2	Electrical Testing		Subgroups 2 and 3	•		
Subgroup 6 – Available Upon Request						
1	Thermal Resistance	MIL-STD-750 – Method 4081	Sample Size – Large Lot = 22(0), Small Lot = 8(0)	•		
Subgroup 7			Large Lot = 32(0), Small Lot = 12(0)			
1	High Temperature Life	MIL-STD-750 – Method 1032	t = 340 Hours @ Max. Rated Storage Temp.,	•		
2	Electrical Testing		DC @ T <sub>A</sub> = 25 °C, Sample Size	•		

### Group B Inspection for JANTX and JANTXV in Accordance with Table E-VIB-MIL-PRF-19500

Step	Process	Conditions	Comments	JANS	JANTXV	JANTX
Subgroup 1						
1	Solderability	MIL-STD-750 – Method 2026	Sample Size = 15(0) Leads, Small Lot = 4 (0) Leads		•	•
2	Resistance to Solvents	MIL-STD-750 – Method 1022	Sample Size = 15(0), Small Lot = 3(0) Devices		•	•
Subgroup 2			Sample Size = 22(0), Small Lot 6(0)			
1	Temperature Cycling	MIL-STD-750 – Method 1051	25 Cycles. Condition C		•	•
2	Fine Leak	MIL-STD-750 – Method 1071	Condition H		•	•
3	Gross Leak	MIL-STD-750 – Method 1071	Condition C		•	•
4	Electrical Testing		DC @ T <sub>A</sub> = 25 °C		•	•
Subgroup 3			Sample Size = 45(0), Small Lot = 12(0)			
1	Steady-State Operation Life	MIL-STD-750 – Method 1027	t = 340 Hours		•	•
2	Electrical Testing		DC @ T <sub>A</sub> = 25 °C		•	•
3	Bond Strength	MIL-STD-750 – Method 2037	Sample Size = 11 Wires(0)		•	•
Subgroup 4						
1	Decap Internal Visual	MIL-STD-750 – Method 2075	Sample Size = 1(0)		•	•
Subgroup 5 – Available Upon Request						
1	Thermal Resistance	MIL-STD-750 – Method 4081	Sample Size = 15(0), Small Lot = 6(0)		•	•
Subgroup 6			Sample Size = 32(0), Small Lot = 12(0)			
1	High Temperature Life	MIL-STD-750 – Method 1032	t = 340 Hours @ Max. Rated Storage Temp.,		•	•
2	Electrical Testing		DC @ T <sub>A</sub> = 25 °C		•	•



## Screening Requirements for Ceramic Packaged Diode Devices (Continued)

Group C Inspection in Accordance with Table E-VII-MIL-PRF-19500

Step	Process	Conditions	Comments	JANS	JANTXV	JANTX
Subgroup 1						
1	Physical Dimensions	MIL-STD-750 – Method 2066	Sample Size = 15(0), Small Lot = 6(0)		•	•
Subgroup 2						
			Sample Size = 22(0), Small Lot = 6(0)			
1	Thermal Shock	MIL-STD-750 – Method 1056	Condition B	•	•	•
2	Temperature Cycling	MIL-STD-750 – Method 1051	25 Cycles. Condition C	•	•	•
3	Terminal Strength	MIL-STD-750 – Method 2036		•	•	•
4	Fine Leak	MIL-STD-750 – Method 1071	Condition H	•	•	•
5	Gross Leak	MIL-STD-750 – Method 1071	Condition C	•	•	•
6	Moisture Resistance	MIL-STD-750 – Method 1021		•	•	•
7	Electrical Testing		DC @ T <sub>A</sub> = 25 °C	•	•	•
Subgroup 3						
			Sample Size = 22(0), Small Lot = 6(0)			
1	Shock	MIL-STD-750 – Method 2016	1,500 Gs, X1, Y1 and Z1.	•	•	•
2	Vibration, Variable Frequency	MIL-STD-750 – Method 2056		•	•	•
3	Constant Acceleration	MIL-STD-750 – Method 2006	10,000 Gs, X1, Y1 and Z1.	•	•	•
4	Electrical Testing		DC @ T <sub>A</sub> = 25 °C	•	•	•
Subgroup 4						
1	Salt Atmosphere	MIL-STD-750 – Method 1041	Sample Size = 15(0), Small Lot = 6(0)	•	•	•
Subgroup 5 – Available Upon Request						
1	Thermal Resistance	MIL-STD-750 – Method 4081	Sample Size = 15(0), Small Lot = 6(0)	•	•	•
Subgroup 6						
			Sample Size = 22(0), Small Lot = 12(0)			
1	Steady-State Operation Life	MIL-STD-750 – Method 1026	1,000 Hours	•	•	•
2	Electrical Testing		DC @ T <sub>A</sub> = 25 °C	•	•	•
Subgroup 7 – Not Applicable						

**Screening Requirements for Ceramic Packaged Diode Devices (Continued)**

Group E Inspection in Accordance with Table E-IX-MIL-PRF-19500

Step	Process	Conditions	Comments	JANS	JANTXV	JANTX
Subgroup 1			Sample Size = 45(0)			
1	Temperature Cycling	MIL-STD-750 – Method 1051	500 Cycles. Condition C	•	•	•
2	Fine Leak	MIL-STD-750 – Method 1071	Condition H	•	•	•
3	Gross Leak	MIL-STD-750 – Method 1071	Condition C	•	•	•
4	Electrical Testing		DC @ T <sub>A</sub> = 25 °C	•	•	•
Subgroup 2			Sample Size = 45(0)			
1	Steady-State Operation Life	MIL-STD-750 – Method 1026	t = 1,000 Hours	•	•	•
2	Electrical Testing		DC @ T <sub>A</sub> = 25 °C	•	•	•
Subgroup 3 – Not Applicable						
Subgroup 5 – Available Upon Request						
1	Thermal Impedance			•	•	•
Subgroup 5 – Not Applicable						
Subgroup 6						
1	ESD	MIL-STD-750 – Method 1020	Sample Size = 11(0)	•	•	•
Subgroup 7			Sample Size = 3(0)			
1	Resistance to Soldering Heat	MIL-STD-750 – Method 2031		•	•	•
2	External Visual Inspection	MIL-STD-750 – Method 2071		•	•	•
3	Fine Leak	MIL-STD-750 – Method 1071	Condition H	•	•	•
4	Gross Leak	MIL-STD-750 – Method 1071	Condition C	•	•	•
5	Electrical Testing		DC @ T <sub>A</sub> = 25 °C	•	•	•
Subgroup 8 – Not Applicable						
Subgroup 9 – Not Applicable						

## MIL-PRF-38534

Step	Screen	Test Methods and Conditions	Class K	Class H
1	Preseal Burn-in	MIL-STD-883, Method 1030	Optional	Optional
2	"100% Nondestructive Bond Pull"	MIL-STD-883, Method 2023, 2% PDA	100%	Optional
3	Internal Visual	MIL-STD-883, Method 2017	100%	100%
4	Temperature Cycling	"MIL-STD-883, Method 1010, Condition C"	100%	100%
5	Constant Acceleration	"MIL-STD-883, Method 2001, Condition 3,000 g, Y1 Direction Only"	100%	100%
6	"Particle Impact Noise Detection (PIND) See Note 1"	"MIL-STD-883, Method 2020, Condition A (Class K) or B"	100%	Optional
7	Preburn-in Electrical Test	"Table 6-3, Subgroup 1; Read and Record"	100%	Optional
8	Burn-in	"MIL-STD-883, Method 1015, at 125 °C Minimum"	160 Hours	160 Hours
9	Interim Electrical	Group A ( Read and Record)	100%	
10	Burn-in	"MIL-STD-883, Method 1015, at 125 °C Minimum"	160 Hours	
11	Final Electrical Test	"Table 6-3, Subgroup 1 -3, 9-11; Read and Record Delta per Table 6-4."	100%	100%
12	PDA	"Calculate Delta and Percent Defective"	100%	100%
13	Fine Leak	"MIL-STD-883, Method 1014, Conditions A or B"	100%	100%
14	Gross Leak	MIL-STD-883, Method 1014, Condition C	100%	100%
15	X-ray	MIL-STD-883, Method 2012	100%	Optional
16	External Visual	MIL-STD-883, Method 2009	100%	100%

## High-reliability Screening Capabilities

### MIL-PRF-38535

Step	Screening Tests	Class B	Class S
1	Wafer Lot Acceptance Test	"QM plan (See H.3.2.1.4) 1/"	"QM plan (see H.3.2.1.4) or TM 5007 of MIL-STD-883 (All Lots)"
2	"Nondestructive bond pull (NDBP) test"		TM 2023
3	Internal Visual Inspection	TM 2010, Condition B	TM 2010, Condition A
4	Temperature Cycling	"TM 1010, Condition C, 10 Cycles Minimum"	"TM 1010, Condition C, 10 Cycles Minimum"
5	Constant Acceleration	TM 2001, Condition E (Minimum), Y1 Orientation Only	TM 2001, Condition E (Minimum), Y1 Orientation Only
6	Visual Inspection	100%	100%
7	"Particle Impact Noise Detection (PIND) test"		"TM 2020, Test Condition A on Each Device"
8	Serialization	In Accordance with Device Specification (100%)	In Accordance with Device Specification (100%)
9	Pre burn-in (Interim) Electrical Parameters Test	In Accordance with Device Specification	In Accordance with Device Specification
10	"Burn-in test"	"TM 1015 160 Hours at +125 °C Minimum"	"TM 1015 240 Hours at 125 °C, Condition D"
11	Post Burn-in (Interim) Electrical Parameters Test		In Accordance with Device Specification
12	"Reverse Bias Burn-in Test (Static Burn-in)"		"TM 1015, Condition A or C; 144 Hours at +125 °C or 72 Hours at +150 °C Minimum"
13	"Post Burn-in (Interim-reverse Bias) Electrical Parameters Test"		In Accordance with Device Specification
		Class Q (Class Level B)	Class V (Class Level S)
14	"Percent Defective Allowable (PDA) Calculation"	5 Percent PDA (All Lots)	"5 Percent PDA, 3 Percent PDA for Functional Parameters at 25 °C (All Lots)"
15	"Final Electrical Tests a. Static Test: (1) at 25 °C (2) Maximum and Minimum Operating Temperature b. Dynamic or Functional Test: (2) Maximum and Minimum Operating Temperature c. Switching Test: (1) at 25 °C (2) Maximum and Minimum Operated Temperature"	"In Accordance with Applicable Device Specification (See Group A Test)"	"In Accordance with Applicable Device Specification (See Group A Test)"
16	"Seal Test a. Fine Leak b. Gross Leak"	TM 1014	TM 1014
17	"Radiographic (X-ray) and/or C-SAM test"		X-ray: TM 2012, Two Views; C-SAM TM 2030
18	"External Visual Inspection"	TM 2009	TM 2009
19	Qualification or Quality Conformance Inspection/TCl Test Sample Selection		
20	Radiation Dose Rate Induced Latch-up Test	TM 1020	TM 1020

Isolink provides discrete “bare die” and beam-lead products with Class H and Class K element evaluation in accordance with MIL-PRF-38534 for microcircuit and semiconductor die and for passive devices.

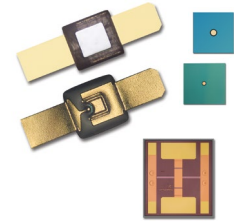

IE:      CLA4601-000 = Commercial Product Flow  
           CLA4601H000 = Class H  
           CLA4601K000 = Class K

### High-reliability Product Flow for Element Evaluation for Unpackaged Devices

Product	MIL-PRF-38534	Application
Bare Die	Class H Class K	Military Space

### Chip Element Evaluation for Microcircuits and Semiconductors

Test Inspection	Mil-Std-883		Requirement	
	Method	Condition	Class H	Class K
Element Electrical	Per Product Specification	On-wafer	100%	100%
Element Visual	2010	A = Class K B = Class H	100%	100%
Internal Visual	2010		10/0	10/0
Stabilization Bake	1008	C	N/A	10/0
Temperature Cycling	1010	C	N/A	10/0
Mechanical Shock or Constant Acceleration	2002 2001	B, Y1 Direction A, Y1 Direction	N/A	10/0 10/0
Interim Electrical	Per Product Specification	25 °C, Min. and Max. Operating Temps.	N/A	
Burn-in	1015	240 Hours Min. @ 125 °C	N/A	10/0
Post Burn-in Electrical	Per Product Specification	25 °C, Min. and Max. Operating Temps.	N/A	10/0
Steady-State Life	1005	1,000 Hours Min. @ 125 °C	N/A	10/0
Final Electrical	Per Product Specification	25 °C, Min. and Max. Operating Temps.	10/0	10/0
Wire Bond Evaluation	2011	C	10/0	10/0
SEM	2018		N/A	4/0

### Chip Element Evaluation for Passive Devices

Subgroup	Class		Test	Method	MIL-STD-883	Quantity (Accept Number) Condition	Reference Paragraph
	K	H					
1	•	•	Element Electrical			100%	C.3.4.1
2	•	•	Visual Inspection	2032		100% 22 (0)	C.3.4.2
	•		Temperature Cycling	1010	C	10 (0)	C.3.4.3
	•		Mechanical Shock or	2002	B, V1 Direction	10 (0)	
	•		Constant Acceleration	2001	3,000Gs Y1 Direction	10 (0)	
	•		Voltage Conditioning or			10 (0)	C.3.4.7
	•		Aging (Capacitors)			10 (0)	
	•		Visual Inspection	2032		10 (0)	C.3.4.5
	•	•	Electrical			10 (0)	C.3.4.4
4	•	•	Wire Bond Evaluation	2011		10 (0) Wires or 20 (1) Wires	C.3.4.3 C.3.4.6

# Product Specifications

Specifications tables for all of our latest Aerospace and Defense products are provided on the following pages.

## Amplification

The primary purpose of amplifiers is to make a small signal larger. Amplifiers may be specialized for specific applications, such as low noise amplifiers (LNAs) for receiver front ends, or they may be designed for general purpose amplification, such as broadband gain blocks.

LNAs are designed to produce optimum noise figure, excellent distortion performance, and outstanding gain.

Gain blocks are designed for ease of circuit design, since they require no input or output impedance matching structures, and very broadband operation.

### WiFi Connectivity Amplifiers

#### 2.5 GHz Power Amplifiers for WiFi Connectivity

Part Number	Frequency Range (GHz)	Test Frequency (GHz)	Typ. Gain (dB)	OIP3 (dBm)	P <sub>1dB</sub> (dBm)	Typ. Quiescent Current (mA)	Typ. Noise Figure (dB)	Package (mm)
SE2623L	2.5–2.5	2.45	33	–	32	–	–	16L QFN 3 x 3 x 0.9

### WiFi Connectivity Amplifiers

#### 5 GHz Power Amplifiers for WiFi Connectivity

Part Number	Frequency Range (GHz)	Test Frequency (GHz)	Typ. Gain (dB)	OIP3 (dBm)	P <sub>1dB</sub> (dBm)	Typ. Quiescent Current (mA)	Typ. Noise Figure (dB)	Package (mm)
 SE5003L1-R	5.15–5.85	5.4	32	–	32	120	–	20L QFN 4 x 4 x 0.9



## Amplification

### Low Noise Amplifiers 400 MHz to 6 GHz

Part Number	Frequency Range (GHz)	Test Frequency (MHz)	Gain (dB)	NF (dB)	OIP3 (dBm)	OP <sub>1dB</sub> (dBm)	V <sub>DD</sub> (V) (Operating Range)	I <sub>DD</sub> (mA) (Operating Range)	Package (mm)
SKY67101-396LF	0.4–1.2	900	17.5	0.50	34.0	19.0	4 (3.3–5.0)	56 (20–90)	DFN 8L 2 x 2 x 0.75
SKY67100-396LF	1.2–2.3	1950	17.5	0.70	34.0	18.5	4 (3.3–5.0)	56 (20–90)	DFN 8L 2 x 2 x 0.75
SKY67102-396LF	2.0–3.0	2600	17.2	0.80	33.8	15.0	4 (3.3–5.0)	50 (20–90)	DFN 8L 2 x 2 x 0.75
SKY67111-396LF	0.7–1.2	900	20.7	0.50	39.6	20.0	5 (3.3–5.0)	77 (50–120)	DFN 8L 2 x 2 x 0.75
SKY67105-306LF	0.6–1.1	850	37.0	0.70	41.0	26.0	5 (3.5–5.0)	138 (120–155)	QFN 16L 4 x 4 x 0.90
SKY67106-306LF	1.5–3.0	1950	35.0	0.65	37.0	24.0	5 (3.5–5.0)	100 (80–125)	QFN 16L 4 x 4 x 0.90
SKY67107-306LF	2.3–2.8	2600	32.0	0.85	37.5	18.5	5 (3.5–5.0)	125 (50–145)	QFN 16L 4 x 4 x 0.75
SKY67012-396LF	0.3–0.6	450	16.5	0.85	24.0	14.0	3.3 (1.8–5.0)	15 (5–30)	DFN 8L 2 x 2 x 0.75
SKY67013-396LF	0.6–1.5	900	14.0	0.85	26.0	15.5	3.3 (1.8–5.0)	15 (5–30)	DFN 8L 2 x 2 x 0.75
SKY67014-396LF	1.5–3.0	2450	12.0	0.95	18.0	6.0	3.3 (1.8–5.0)	5 (5–30)	DFN 8L 2 x 2 x 0.75
SKY67015-396LF	0.03–0.3	250	17.5	0.90	26.0	12.5	3.3 (1.8–5.0)	18 (5–30)	DFN 8L 2 x 2 x 0.75
SKY65404-31	4.9–5.9	5800	13.0	1.20	20.0	9.0	3.3 (2.8–5.0)	11 (10–15)	DFN 6L 1.5 x 1.5 x 0.45
SKY65405-21	2.4–2.5	2450	15.0	1.10	24.0	15.0	3.3 (2.8–5.0)	12 (10–16)	DFN 6L 1.5 x 1.5 x 0.45
SKY67151-396LF	0.7–3.8	1500	22.0	0.30	37.0	20.0	5 (3.3–5.0)	65 (20–90)	DFN 8L 2 x 2 x 0.75

### Gain Block (General Purpose) Amplifiers

Part Number	Frequency Range (GHz)	Test Frequency (MHz)	Typ. Gain (dB)	OIP3 (dBm)	P <sub>1dB</sub> (dBm)	Typ. Quiescent Current (mA)	Typ. Noise Figure (dB)	Package (mm)
SKY65013-70LF	0.1–7	2.0	12.5	29	12.5	40	5.5	4-pin SOT-89 4.5 x 2.5 x 1.5
SKY65014-70LF	0.1–6	2.0	16.0	36	18.0	70	4.8	4-pin SOT-89 2.4 x 4.5 x 1.5
SKY65015-70LF	0.1–6	2.0	18.0	35	17.0	70	4.2	4-pin SOT-89 4.5 x 2.5 x 1.5
SKY65016-70LF	0.1–3	2.0	20.0	27	14.0	40	4.8	4-pin SOT-89 4.5 x 2.5 x 1.5
SKY65017-70LF	0.1–6	2.0	20.0	35	20.0	100	4.5	4-pin SOT-89 4.5 x 2.5 x 1.5
SKY67130-396LF	0.7–2.7	2.6	13.0	39	16.0	22	2.6	8-pin DFN 2 x 2 x 0.75

## Amplification

### Variable Gain Amplifiers (VGAs)

Part Number	Operating Frequency (MHz)	Architecture	Attenuation Type	Gain Control Range (dB)	Gain Step Size (dB)	Gain (dB)	Min. NF	IP3 (dBm)	P <sub>1dB</sub> (dBm)	Supply Voltage (V)	Package (mm)
SKY65172	400–2700	Single Channel	Digital/ Analog	25 (Analog) 31.5 (Digital)	N/A 0.5	26.5	5	OIP3 = 38	OP <sub>1dB</sub> = 24.5	5	48-pin MCM 7 x 7 x 1.1
SKY65175	1710–1950	Single Channel	Analog	18	N/A	26	2.8	OIP3 = 41.5	OP <sub>1dB</sub> = 29	5	12-pin MCM 8 x 8 x 1.35
SKY65185	1700–2700	Dual Channel	6-bit Digital	31.5	0.5	15	4.5	OIP3 = 41	OP <sub>1dB</sub> = 26	5	32-pin MCM 7 x 7 x 1.35
SKY65186-11	330–2700	Dual Channel	Digital	31.5	0.5	13.5	5	OIP3 = 36	OP <sub>1dB</sub> = 20	5	32-pin MCM 7 x 7 x 1.35
SKY65187-11	2000–2230	Single Channel	Analog	30	N/A	24	2.7	OIP3 = 41.5	OP <sub>1dB</sub> = 28	5	12-pin MCM 8.385 x 8.385 x 1.35
SKY65373-11	1710–1785	Single Channel	Voltage Controlled	35	Analog	35	1	IIP3 = 3	OP <sub>1dB</sub> = -11	5	16-pin MCM 8 x 8 x 1.3
SKY65386-11	2620–2690	Single Channel	Analog	42	N/A	25.5	3.9	OIP3 = 41.5	OP <sub>1dB</sub> = 28.5	5	12-pin MCM 8.385 x 8.385 x 1.35
SKY65387-11	2000–2230	Single Channel	Analog	35	N/A	30	3.5	OIP3 = 42	OP <sub>1dB</sub> = 28	5	12-pin MCM 8.385 x 8.385 x 1.35

# Attenuation

Attenuators are used to adjust signal levels, to compensate for impedance mismatches, and to enhance isolation, among other uses. Attenuators may be electronically variable or may offer fixed values of attenuation. Skyworks' offering of digital and variable attenuators, attenuator PIN diodes, and fixed attenuators are shown in the following tables.

The attenuation of variable attenuators is controlled by one or more external signals. One type of variable attenuators, digital variable attenuators, produces discrete combinations of attenuation values, which comprise one or more bits which are typically binary weighted values. The attenuation produced by voltage variable attenuators is continuously variable under the control of an analog voltage.

Fixed attenuators contain fixed resistors, typically connected in tee or p networks. The attenuation values of these fixed attenuators range from 0 to 30 dB.

Variable attenuators are available in several different surface mount plastic package styles. The fixed attenuators are available as unpackaged dice.

## Digital Attenuators

### Digital Attenuators for IF/UHF/VHF and Broadband RF Applications

Part Number	Frequency Range (GHz)	Number of Bits	Least Significant Bit (dB)	Control Interface	Maximum Attenuation (dB)	Typical Insertion Loss (dB)	Typical IIP3 (dBm)	Package (mm)
SKY12406-360LF	0.05–0.6	1	12	Parallel	12	0.3	46	QFN 8L 2 x 2 x 0.9
AA116-72LF	0.004–2.0	1	15	Parallel	15	0.35–0.4	41	SOT-23 5L 2.8 x 2.9 x 1.18
SKY12407-321LF	0.05–0.6	2	12	Parallel	12 (100 $\Omega$ Differential I/O)	0.3	48	QFN 12L 3 x 3 x 0.75
SKY12338-337LF	0.35–4.0	2	6	Parallel	18	0.55–1.3	45	QFN 12L 3 x 3 x 0.75
SKY12325-350LF	0.5–6.0	3	1	Parallel	7	0.7–1.3	47	QFN 16L 3 x 3 x 0.75
SKY12348-350LF	0.1–3.0	4	1	Parallel	15	0.8–1.2	45	QFN 16L 3 x 3 x 0.75
SKY12340-364LF	0.3–2.0	5	0.5	SPI	15.5	1.4–1.8	45	QFN 32L 5 x 5 x 0.9
SKY12322-86LF	0.5–4.0	5	0.5	Parallel	15.5	1.4–3.0	45	MSOP 10L 4.9 x 3 x 0.96
SKY12345-362LF	0.7–4.0	5	0.5	SPI	15.5	1.2–2.0	42	QFN 24L 4 x 4 x 0.9
SKY12347-362LF	LF–3.0	6	0.5	SPI or Parallel	31.5	1.2–2.0	50	QFN 24L 4 x 4 x 0.9
SKY12343-364LF	0.01–4.0	7	0.25	SPI or Parallel	31.75	1.8–1.9	50	QFN 32L 5 x 5 x 0.9

## Attenuation

### Variable Attenuators—FET Based

#### 3.0–3.8 GHz Plastic Packaged Voltage Variable Attenuators

Part Number	Frequency (GHz)	Description	Typ. Insertion Loss Range (dB)	Attenuation Range (dB)	Typ. IP3 > 0.5 GHz (dBm)	Package (mm)
SKY12146-321LF	3.0–3.8	20 dB Single CTL	1.5–1.6	32–20	20	QFN 12L 3 x 3 x 0.75

#### ATN3590 Fixed Attenuator Pads

Part Number	Nominal Attenuation (dB)	Attenuation Tolerance @ DC (dB)	Attenuation Flatness				Return Loss			
			DC–12 GHz (dB)	12–26 GHz (dB)	26–33 GHz (dB)	33–40 GHz (dB)	DC–12 GHz (dB)	12–26 GHz (dB)	26–33 GHz (dB)	33–40 GHz (dB)
ATN3590-00	0	0.25	±0.15	±0.15	±0.20	±0.20	28	24	20	16
ATN3590-01	1	±0.20	±0.15	±0.15	±0.20	±0.20	28	24	20	16
ATN3590-02	2	±0.20	±0.15	±0.15	±0.20	±0.20	28	24	20	16
ATN3590-03	3	±0.20	±0.15	±0.15	±0.20	±0.20	28	24	20	16
ATN3590-04	4	±0.20	±0.15	±0.15	±0.20	±0.20	28	24	20	16
ATN3590-05	5	±0.20	±0.15	±0.15	±0.20	±0.20	28	24	20	16
ATN3590-06	6	±0.40	±0.15	±0.15	±0.20	±0.20	28	24	20	16
ATN3590-07	7	±0.40	±0.15	±0.15	±0.20	±0.20	28	24	20	16
ATN3590-08	8	±0.40	±0.15	±0.15	±0.20	±0.20	28	24	20	16
ATN3590-09	9	±0.40	±0.20	±0.20	±0.25	±0.30	28	24	20	16
ATN3590-10	10	±0.40	±0.20	±0.20	±0.25	±0.50	28	24	20	16
ATN3590-12	12	±0.40	±0.20	±0.20	±0.30	±0.50	28	24	20	16
ATN3590-15	15	±0.40	±0.20	±0.20	±0.50	±0.75	28	24	20	16
ATN3590-20	20	±1.0	±0.20	±0.20	±0.75	±1.0	28	24	20	16
ATN3590-30	30	±1.0	±0.20	±0.25	±0.75	±2.5	28	24	20	16

## Attenuation

### Attenuator PIN Diodes

#### PIN Diode Discrete—Low Frequency to 12 GHz

Part Number	Nominal Input 3rd Order Intercept (dBm) <sup>1</sup>	Nominal I Layer Thickness (μm)	Nominal Largest Series Resistance (kΩ)	Minimum Series Resistance (Ω)	Maximum Capacitance (pF)	Nominal Carrier Lifetime (ns)
SMP1307 Series	>50	175	3.0	3.0 @ 100 mA	0.3 @ 30 V	1500
SMP1304 Series	>43	100	2.5	2.0 @ 100 mA	0.3 @ 30 V	1000
SMP1302 Series	>38	50	1.8	1.5 @ 100 mA	0.3 @ 30 V	700
APD2220-000	>38	50	1.8	1.5 @ 100 mA	0.2 @ 50 V	700

1. Input third order intercept (IIP3) is dependent on several factors, including signal frequency, bias condition and attenuator topology. Values shown here refer to hybrid coupler attenuator topology, signal frequency equal to the center frequency of the hybrid coupler, with bias adjusted to produce minimum attenuation. IIP3 typically degrades by approximately 6 dB when attenuation is adjusted to maximum.

Screened bare die, epoxy and ceramic hermetic packaged versions of these devices are available through Isolink (a wholly owned subsidiary of Skyworks Solutions, Inc.) For more information, please visit the Isolink website at [www.skyworksinc.com/Isolink](http://www.skyworksinc.com/Isolink).

#### AEC-Q101 Qualified<sup>2</sup>

Part Number	Min. $V_B$ $I_r = 10 \mu A$ (V)	Max. $C_T$ $V_r = 30 V$ (pF)	Typ. $V_F$ $I_F = 10 mA$ (V)	Max. $R_S$ $I_F = 1 mA$ $F = 100 MHz$ (Ω)	Max. $R_S$ $I_F = 10 mA$ $F = 100 MHz$ (Ω)	Max. $R_S$ $I_F = 100 mA$ $F = 100 MHz$ (Ω)	Typ. Carrier Lifetime $I_F = 10 mA$ (ns)	Package (mm)
SMPA1302-079LF	200	0.30	0.80	20	3	1.5	700	QFN 2L 2 x 2 x 0.9
SMPA1304-011LF	200	0.30	0.80	50	7	2.0	1000	SOD 2L 2.52 x 1.25 x 1.04

2. Not all stresses listed within AEC-Q101 have been performed. Qualification report available upon request.

Contact your sales representative for more information. For the full details of Skyworks Quality and Reliability on our products that can be designed into automotive applications, please view the "Skyworks Quality Standards for Automotive Customers" on our website.

# Circulation and Isolation

Skyworks is now pleased to offer customers innovative and cost-competitive ferrite circulators and isolators for both military and commercial markets. Our circulators deliver industry-leading insertion loss performance, a critical parameter in radar design, of less than 0.25 dB. Skyworks' MAFR-000493-000001, for example, is designed to operate in the L band. It has a typical insertion loss of just 0.16 dB at 1030 MHz. Our MAFR-000403 S band circulator, optimized from 2.7 GHz to 3.1 GHz, has a typical insertion loss of only 0.25 dB. Skyworks achieves best-in-class performance through a systematic approach including Six Sigma tools and methodologies, which help ensure quality and reliability from product development through volume production. All production facilities are certified to ISO 9001 and ISO 14001 standards and our products are compliant to the European Union's RoHS directive 2002/95/EC.

## Circulators for Radar Applications

Part Number	Frequency (MHz)	Insertion Loss (dB)	Isolation (dB)	Return Loss (dB)	Rotation	Max. Power (W) F/R	Case Size (Inch/mm)	Package
MAFR-000399-000001	1450–1500	0.30	20	20	CW	1000	1.0/25.4	Drop-in
MAFR-000409-000001	960–1200	0.50	18	18	CCW	1000	1.0/25.4	Drop-in
MAFR-000428-000001	960–1200	0.50	18	18	CCW	1200	1.0/25.4	Drop-in
MAFR-000493-000001	1030–1090	0.30	18	18	CW	1200	1.0/25.4	Drop-in
MAFR-000514-000001	3100–3500	0.30	23	21	CW	1500/1500	0.75 <sup>2</sup> /19 <sup>2</sup>	Drop-in
MAFR-000578-000001	1200–1400	0.30	20	20	CW	1500	1.0/25.4	Drop-in
MAFR-000608-000001	1200–1400	0.30	20	20	CCW	1500	1.0/25.4	Drop-in
MAFR-000613-000001	1030–1090	0.30	18	18	CW	1200/1200	1.0 <sup>2</sup> /25.4 <sup>2</sup>	Drop-in
MAFR-000627-000001	1350–1850	0.50	18	18	CW	1500	1.0/25.4	Drop-in
MAFR-000645-000001	960–1215	0.50	16	16	CCW	1000/1000	1.0 <sup>2</sup> /25.4 <sup>2</sup>	Drop-in
MAFR-000668-000001	1350–1850	0.50	18	18	CCW	1500/1500	1.02/25.42	Drop-in
MAFR-000677-000001	2700–3100	0.35	20	20	CW	1300/1300	0.75 <sup>2</sup> /19 <sup>2</sup>	Drop-in
SKYFR-000784	1350–1850	0.50	18	18	CCW	1000	1.0/25.4	Drop-in
SKYFR-000900	1200–1400	0.30	20	20	CCW	1500	1.0/25.4	Drop-in
SKYFR-001123	2700–3100	0.35	20	20	CW	1300	0.75/19.0	Drop-in
SKYFR-001208	1350–1850	0.50	18	18	CW	1000	1.0/25.4	Drop-in

## Isolators for Radar Applications

Part Number	Frequency (MHz)	Insertion Loss (dB)	Isolation (dB)	Return Loss (dB)	Rotation	Max. Power (W) F/R	Case Size (Inch/mm)	Package
MAFR-000430-000001	2700–3100	0.30	20	20	CW	1300/75	0.75 x 1.0/19 x 25.4	Drop-in
MAFR-000628-000001	1200–1400	0.30	20	20	CCW	1500/2	1.0/25.4	Drop-in
MAFR-000629-000001	1200–1400	0.30	20	20	CW	1500/25	1.0 x 1.25/25.4 x 31.7	Drop-in
MAFR-000667-000001	1200–1400	0.30	20	20	CCW	1500/25	1.0 x 1.25/25.4 x 31.7	Drop-in



# DC Blocking and Filtering

Skyworks' metal-insulator-semiconductor (MIS) chip capacitors are available in a wide range of capacitance values and die sizes for chip-and-wire circuits requiring DC blocking, RF bypassing or as tuning elements in filters, oscillators, and matching networks. The capacitors have a dielectric composed of thermally-grown silicon dioxide over which a layer of silicon nitride is deposited. This two-layer dielectric produces a very low temperature coefficient of capacitance, very high insulation resistance, outstanding long-term stability, and excellent reliability. The temperature coefficient of capacitance is less than 50 ppm/°C, and the capacitors are suitable for operation from -65 °C to 200 °C. Skyworks' MIS chip capacitors offer very high Q. Wafers can be supplied on expanded film frame for automatic pick-and-place manufacturing. To reduce cost, chips can be supplied packaged in vials with sample electrical testing. Packaging in waffle packs with 100% electrical test and visual inspection is available if required.

## MIS Silicon Chip Capacitors—Low Frequency to 20 GHz

Part Number	Capacitance Value (pF) ±20%	Die Size (mils)
SC00080912	0.8	12 x 12
SC00120912	1.2	12 x 12
SC00180912	1.8	12 x 12
SC00260912	2.6	12 x 12
SC00380912	3.8	12 x 12
SC00560912	5.6	12 x 12
SC00680912	6.8	12 x 12
SC00820710	8.2	10 x 10
SC00821518	8.2	18 x 18
SC01000710	10	10 x 10
SC01000912	10	12 x 12
SC01001518	10	18 x 18
SC01500912	15	12 x 12
SC01501518	15	18 x 18
SC02201518	22	18 x 18
SC03301518	33	18 x 18
SC04701518	47	18 x 18
SC06801518	68	18 x 18
SC10002430	100	30 x 30
SC33303440	333	40 x 40
SC50004450	500	50 x 50
SC99906068	1000	68 x 68

Screened bare die, epoxy and ceramic hermetic packaged versions of these devices are available through Isolink (a wholly owned subsidiary of Skyworks Solutions, Inc.). For more information, please visit the Isolink website at [www.skyworksinc.com/Isolink](http://www.skyworksinc.com/Isolink).

# Demodulation

Demodulation is a process in which information, known as the baseband signal, is recovered from a modulated carrier signal. Typically, the carrier signal frequency is higher than that of the baseband signal, so a frequency-down conversion is inherently involved in demodulation. Skyworks offers a family of I/Q demodulators which produce complex baseband signals by processing the modulated carrier signal and a high frequency local oscillator signal. Baseband signals are comprised of in-phase (I) and quadrature (Q) baseband signals, (IQ signals), which can be produced from the demodulation of any digital or analog modulation.

Frequency conversion mixers, modulators, and demodulators all require stable, low noise local oscillator signals (LO signals) in order to perform their primary functions. Skyworks offers advanced phase locked loop (PLL)/synthesizers which produce high frequency signals which are locked to low frequency, very stable reference frequency signals through the use of advanced frequency dividers, and phase/frequency detectors. These circuits offer exceptional phase noise performance, very low spurious signal content, excellent frequency agility, and very fast settling without sacrificing spectral purity.

These devices are available with or without internal high-frequency voltage-controlled oscillators, with “integer-n” or “fractional-n” frequency dividers and as single or dual PLL/synthesizers.

## PLLs/Synthesizers/VCOs

### High Performance VCOs/Synthesizers

Part Number	RF Output Frequency Range (MHz)	Output Power (dBm)	Phase Noise @ 200 kHz (dBc/Hz)	Phase Noise @ 800 kHz (dBc/Hz)	Phase Settling Time (μs)	Current Consumption (mA)	Supply Voltage (V)	Package (mm)
SKY73101-11	1930–1990	-10	-112	-139	300	120	5	38-pin MCM 9 x 12 x 1.7
SKY73120	890–960	0	-124	-144	–	26	3	28-pin MCM 6 x 6 x 0.9
SKY73121-11	1805–1890	-10	-126	-142	227	114	5	38-pin MCM 9 x 12 x 1.7

## Demodulation

### Mixer Modules with Built-in Voltage Controlled Oscillators (VCOs)

Part Number	Operating Frequency (MHz)	IF Frequency (MHz)	Architecture	Power Down	Built-In LO Drivers	Built-In PLL/VCO	Conversion Gain	IIP3 (dBm)	V <sub>CC</sub> (V)	NF (dB)	Package (mm)
SKY73212-11	1700–2000	40–300	Diversity	Yes	Yes	Integer-N	9	24	5	11	44-pin MCM 10 x 6 x 1.05
SKY73208-11	350–5000	50–500	Single	Yes	Yes	Integer-N	6	26	5	14	36-pin MCM 6 x 6 x 1.35

### Dual Fractional-N Synthesizers

Part Number	Main Synthesizer Frequency (MHz)	Auxiliary Synthesizer Frequency (MHz)	Main Synthesizer Phase Noise (dBc/Hz)	Supply Voltage (V)	Package (mm)
SKY74038-21	100–2600	1–800	-85 @ 2500 MHz	2.6–3.6	20-pin TSSOP 6.5 x 4.4 x 1.1

# Filtering



In most radio systems it is necessary to select a certain range of frequencies which the radio processes. Band pass filter structures are utilized to select the appropriate frequency band, to reject all signals whose frequencies are lower than the lower frequency bound of the filter, and to reject all signals whose frequencies are higher than the higher frequency bound of the filter.

Band pass, notch, and diplex filters, in both SMT and connectorized versions, comprising ceramic resonators have very high quality factor (Q), low in-band insertion loss, high out-of-band rejection, and excellent ruggedness. Several band pass filters are available with center frequencies from 225 MHz up to 7.1 GHz. Skyworks, through its subsidiary Trans-Tech, can design and manufacture ceramic resonators from 1.85 mm up to 20 mm and produce high-power filters exceeding 100 CW in SMT and connectorized versions, as well as high frequency options.

When size is an issue, Trans-Tech Inc. can design and manufacture ceramic filter element solutions for your higher power filter requirements. Our designs provide optimized physical volume and minimized weight to meet your demanding requirements.

## Ceramic Filters

Part Number	Market Segment	Filter Type	Size/ poles	F <sub>0</sub>	Bandwidth (MHz)	Insertion Loss (dB)	Package
TT3P4-1255P2-8025	Radio Communications	Band Pass	3 mm/4 pole	1225	80	2.5	SMT
TT3P4-1265.2P2-1040	Radio Communications	Band Pass	3 mm/4 pole	1265	10	4.0	SMT
TT1.85P7-1400P0-20040	Radio Communications	Band Pass	1.85 mm/7 pole	1400	200	4.0	SMT
TT1.85P6-1888P0-22540	Radio Communications	Band Pass	1.85 mm/6 pole	1888	225	4.0	SMT
TT1.85P6-1638P0-27540	Radio Communications	Band Pass	1.85 mm/6 pole	1638	275	4.0	SMT
TT1.85P6-1650P0-30030	Radio Communications	Band Pass	1.85 mm/6 pole	1650	300	3.0	SMT
TT12P8-T310-R370	Radio Communications	Diplexer	12 mm/8 pole	310/370	20	0.7	SMT
TT3P5-1000P3-1030	Ground Radar	Band Pass	3 mm/5 pole	1000	10	3.0	SMT
TT6P4-1575P3-1540	GPS	Band Pass	6 mm/4 pole	1575	15	4.0	SMT
TT4P2-1227P3-2010	GPS	Band Pass	4 mm/2 pole	1227	20	1.0	SMT
TT4P2-1575P3-1014	GPS	Band Pass	4 mm/2 pole	1575	10	1.4	SMT
TT6P4-0373P0-0240	Homeland Security	Band Pass	6 mm/4 pole	373	2	4.0	SMT
TT4P5-1300P2-20010E	Homeland Security	Band Pass	4 mm/5 pole	1300	200	1.0	SMT
TT4P5-2300P2-20010	Homeland Security	Band Pass	4 mm/5 pole	2300	200	1.0	SMT
TT2P4-4700P2-60010	Homeland Security	Band Pass	2 mm/4 pole	4700	600	1.0	SMT

### Notes:

LPA = Linear Power Amps  
 IED = Improvised Explosive Device  
 TCAS = Traffic Collision Avoidance System  
 RC = Radio Communications  
 GPS = Global Positioning System  
 TT4P5-1000P0-10020  
 4P5 = 4 mm/5 pole  
 1000 = Center Frequency  
 10020 = Bandwidth/Insertion Loss

## Filtering

### Ceramic Filters (Continued)

Part Number	Market Segment	Filter Type	Size/ poles	F <sub>0</sub>	Bandwidth (MHz)	Insertion Loss (dB)	Package
TT3P4-0915P2-10020	IED	Band Pass	3 mm/4 pole	915	100	2.0	SMT
TT3P4-2240P2-0545	IED	Band Pass	3 mm/4 pole	2240	5	4.5	SMT
TT4P45-2700P2-5045	IED	Band Pass	4 mm/4 pole	2700	50	4.5	SMT
TT4P6-0925P2-15020	IED	Band Pass	4 mm/6 pole	925	150	2.0	SMT
TT2P4-2650P0-8035	IED	Band Pass	2 mm/4 pole	2650	80	3.5	SMT
TT8P10-R1950-T2140	LPA	Diplexer	8 mm/10 pole	1950/2140	60	2.0	SMT
TT6P4-0480P0-3019	LPA	Band Pass	6 mm/4 pole	480	30	1.9	SMT
TT8P5-1090P0-1050	LPA	Band Pass	8 mm/5 pole	1090	10	5.0	SMT
TT4P4-0255P0-3015	LPA	Band Pass	4 mm/4 pole	255	30	1.5	SMT

Notes:

- LPA = Linear Power Amps
- IED = Improvised Explosive Device
- TCAS = Traffic Collision Avoidance System
- RC = Radio Communications
- GPS = Global Positioning System
- TT4P5-1000P0-10020
- 4P5 = 4 mm/5 pole
- 1000 = Center Frequency
- 10020 = Bandwidth/Insertion Loss

### High Frequency Ceramic Filters

Trans-Tech, Inc. offers a series of high frequency band pass notch filters that are available in surface mount technology (SMT) designs. This series of filters has excellent matching for 50 Ω communication systems where space and weight are critical design criteria.

# Mixing

Frequency conversion circuits are present in many receiver and transmitter architectures. The frequency mixer comprises one or more nonlinear impedance elements which are used to mix a signal of interest by a reference signal, commonly known as the local oscillator (LO) signal, to produce signals at new frequencies. These frequencies include the sum of the signal of interest and the LO signal to produce an upconverted signal, and the difference of the LO signal and the signal of interest, producing a down-converted signal. Upconversion is generally used in transmit architectures while downconversion is generally found in receivers.

The SKY73208-11 is a fully integrated wideband device which consists of three main blocks required in a receive RF subsystem. It contains a wide band mixer for down conversion, a complete voltage controlled oscillator (VCO) synthesizer, and local oscillator (LO). The integrated VCO synthesizer is a wideband integer-N synthesizer which covers frequencies from 2.8–6.0 GHz with competitively low phase noise and very low spurious content.

Schottky diodes produce a nonlinear relationship between current and voltage, that is, they present a nonlinear impedance. They can be used in several different circuit topologies as frequency up- or downconverters.

There are several types of Schottky mixer diodes available. Silicon (Si) Schottky mixer diodes are available with low, medium, and high barrier heights. Lower barrier heights are sensitive to lower power signals and typically require smaller LO power, while higher barrier heights can handle larger signals and typically produce less harmonic and intermodulation distortion. Consequently, downconverter mixers in receivers generally contain low or medium barrier Schottky diodes, while upconverters in transmitters contain medium- or high-barrier Schottky diodes.

Schottky detector diodes are available as beam lead, flip chip, unpackaged dice, in surface-mount plastic packages and in hermetic, ceramic packages.

Beam lead, flip chip, and unpackaged die configurations offer optimal performance since there are no package parasitic reactances present in these configurations.

Plastic-packaged devices are readily surface mountable and present the lowest cost alternative of the available package styles. The parasitic impedances of these packages can reduce the maximum frequency of operation to an extent determined by the magnitude of these parasitic reactances.

Schottky diodes packaged in hermetic, ceramic packages can meet all requirements for high-reliability screening while operating to high frequency, since their parasitic reactances are relatively small. Skyworks' offering of Schottky diodes are shown in the following tables.

Screened bare die, epoxy and ceramic hermetic packaged versions of these devices are available through Isolink (a wholly owned subsidiary of Skyworks Solutions, Inc.)







For more information, please visit the Isolink website at [www.skyworksinc.com/Isolink](http://www.skyworksinc.com/Isolink).

## Mixing

### Mixer Modules with Built-in Voltage Controlled Oscillators (VCOs)

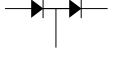
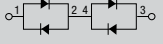
Part Number	Operating Frequency (MHz)	IF Frequency (MHz)	Architecture	Power Down	Built-In LO Drivers	Built-In PLL/VCO	Conversion Gain	IIP3 (dBm)	V <sub>CC</sub> (V)	NF (dB)	Package (mm)
SKY73208-11	350–5000	50–500	Single	Yes	Yes	Integer-N	6	26	5	14	36-pin MCM 6 x 6 x 1.35

### Chip, Beam Lead and 0201 Chip Scale Package (CSP)—Low Frequency to 100 GHz

Configuration	Typical LO Drive Power Range (dBm)	Barrier Height	Base Part Number <sup>1</sup>
Si Ring Quad 	10–14	Low	DMF3926-000, DMF3942-000, DMF2865-000, DMF2454-000
	13–20	Medium	DME3927-000, DME3943-000, DME2857-000, DME2459-000
	17–23	High	DMJ3928-000, DMJ3944-000, DMJ2502-000, DMJ2455-000
Si Bridge Quad 		Low	DMF3929-000, DMF2076-000, DMF2848-000
		Medium	DME3930-000, DME2029-000, DME2851-000
		High	DMJ3931-000, DMJ2312-000, DMJ2852-000
Series Pair 		Low	DMF3932-000, DMF2835-000, DMF2828-000
		Medium	DME3933-000, DME2050-000, DME2831-000
		High	DMJ3934-000, DMJ2092-000, DMJ2833-000
Back-to-Back Ring Series Pairs 		Low	DMF3935-000
		Medium	DME3936-000
		High	DMJ3937-000
Si Dual Ring Quad (Octoquad) 	13–17	Low	DMF3938-000
	16–23	Medium	DME3939-000
	20–27	High	DMJ3940-000
Si Crossover Dual Ring Quad 	13–17	Low	DMF3945-000
	16–23	Medium	DME3946-000
	20–27	High	DMJ3947-000
Si Single 	-3–3	Low	SMS7621-060, DMF2820-000, DMF2822-000
	0–6	Medium	DME2127-000, DME2458-000
	6–13	High	DMJ2823-000, DMJ2825-000
Si Antiparallel 	10–16	Low	DMF2185-000, DMF2186-000, DMF2187-000
	13–20	Medium	DME2282-000, DME2283-000, DME2284-000, DME2838-000
	20–27	High	DMJ2303-000, DMJ2304-000, DMJ2246-000, DMJ2839-000







 Part numbers in this table are Skyworks Green™.

Screened bare die, epoxy and ceramic hermetic packaged versions of these devices are available through Isolink (a wholly owned subsidiary of Skyworks Solutions, Inc.). For more information, please visit the Isolink website at [www.skyworksinc.com/Isolink](http://www.skyworksinc.com/Isolink).

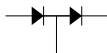

# Mixing

## Ceramic and Hermetic—Low Frequency to 40 GHz

Configuration	Typical LO Drive Power Range (dBm)	Barrier Height	Base Part Number <sup>1</sup>
Si Ring Quad 	10–14	Low	DMF2865, DMF2011, DMF2012, DMF2454
	13–20	Medium	DME2857, DME2858, DME2859, DME2459
	17–23	High	DMJ2502, DMJ2990, DMJ2667, DMJ2455
Si Bridge Quad 		Low	DMF2076, DMF2077, DMF2078, DMF2848
		Medium	DME2029, DME2850, DME2031, DME2851
		High	DMJ2312, DMJ2088, DMJ2768, DMJ2852
Series Pair 		Low	DMF2835, DMF2826, DMF2827, DMJ2828
		Medium	DME2050, DME2829, DME2830, DME2831
		High	DMJ2092, DMJ2093, DMJ2832, DMJ2833
Si Dual Ring Quad (Octoquad) 	13–17	Low	DMF3938-257
	16–23	Medium	DME3939-257
	20–27	High	DMJ3940-257
Si Single 	-3–3	Low	DMF2820, DMF2821, DMF2344, DMF2822
	0–6	Medium	DME2127, DME2957, DME2333, DME2458
	6–13	High	DMJ2823, DMJ2777, DMJ2824, DMJ2825
Si Antiparallel Pair 	10–16	Low	DMF2185, DMF2186, DMF2187, DMF2837
	13–20	Medium	DME2282, DME2283, DME2284, DME2838
	20–27	High	DMJ2303, DMJ2304, DMJ2246, DMJ2839

 Part numbers in this table are Skyworks Green™.

Screened bare die, epoxy and ceramic hermetic packaged versions of these devices are available through Isolink (a wholly owned subsidiary of Skyworks Solutions, Inc.). For more information, please visit the Isolink website at [www.skyworksinc.com/Isolink](http://www.skyworksinc.com/Isolink).

# Optical Coupling



Isolink, Inc., a subsidiary of Skyworks Solutions, Inc., is the leading supplier of high performance and high quality optoelectronic radiation tolerant components worldwide. Expanding on our specialty in manufacturing and production of high quality, high-reliability products for high demand environments, Isolink’s portfolio now includes hermetic packaged RF IC diode and switch products. Isolink’s mission is to provide products and services to the high-reliability, military, aerospace, hybrid, industrial, medical, and telecommunications markets. The company specializes in the manufacture of high-performance miniature hybrids and hermetically sealed RFIC and optocoupler devices. Isolink pioneered the miniaturization of some of the most advanced optoelectronic components. Our expertise in optoelectronic components enables us to make products of high quality, achieving high isolation voltages. A hallmark of Isolink’s products is high common mode rejection and radiation tolerance for high demand environments.

Isolink is committed to providing excellent products and services to its customers, and to serving as an extension of the customer’s engineering and manufacturing resources. Isolink strives for a customer/vendor relationship aimed at optimizing product performance, quality, and cost. We meet and exceed customer expectations, and are committed to delivering excellence.

Isolink works with customers from program inception to the final implementation of the most demanding design and application challenges. We are proud to provide innovative products and custom solutions with uncompromising quality and on-time delivery.

Founded by veterans in the optoelectronics industry, Isolink is headquartered in Milpitas, California.

For more information, or for customer support, please visit the Isolink website at [www.skyworksinc.com/Isolink](http://www.skyworksinc.com/Isolink).

## Photo-transistor Optocouplers

Photo-transistor optocouplers are primarily used for optical isolation, high current transfer ratio, and low saturation Vce. Each unit consists of a light emitting diode and a NPN silicon photo-transistor mounted and coupled in a miniature custom substrate for hybrid assembly or in hermetically sealed packages.

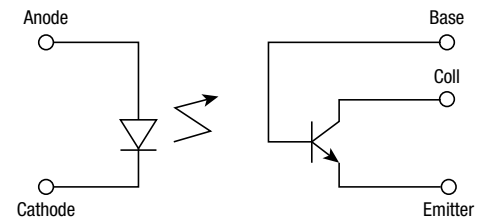

**Photo-transistor Optocoupler Functional Schematic**

### Single-channel Photo-transistor Optocouplers

Part Number	V <sub>F</sub> (V) @ I <sub>F</sub> = 10 mA		CTR @ I <sub>F</sub> (mA)	CTR		BV <sub>ceo</sub> (V)	V <sub>cc</sub> Max. (V)	Isolation 25 °C V <sub>dc</sub> @ 1 s	Package Size (inch)
	Min.	Max.		Min. (%)	Max. (%)				
OLI100	0.9	1.7	1	100	–	30	–	1500	6L 0.1 x 0.11 x 0.65
OLI110	0.9	1.7	1	100	–	60	–	1500	4L 0.09 x 0.09 x 0.08
OLI149 <sup>1</sup>	1.3	1.8	1	200	1200	60	–	1500	4L 0.09 x 0.09 x 0.08
OLI249 <sup>1</sup>	1.3	1.8	1	200	1200	40	–	1500	6L 0.1 x 0.11 x 0.65
OLS010 <sup>2</sup>	0.9	1.6	1	100	–	60	–	1000	4L 0.225 x 0.155 x 0.75
OLS049 <sup>2</sup>	1.8	1.8	1	200	–	60	–	1000	4L 0.225 x 0.155 x 0.75
OLS100	0.9	1.7	1	100	–	30	–	1500	4L 0.225 x 0.155 x 0.75

1. Radiation tolerant.

2. No base connection.

## Photo-transistor Optocouplers

### Single-channel Photo-transistor Optocouplers (Continued)

Part Number	$V_F$ (V) @ $I_F = 10$ mA		$I_F$ (mA)	CTR		$BV_{ce0}$ (V)	$V_{cc}$ Max. (V)	Isolation 25 °C $V_{DC}$ @ 1 s	Package Size (inch)
	Min.	Max.		Min. (%)	Max. (%)				
OLS249 <sup>1</sup>	1.2	1.8	1	200	1200	40	–	1500	6L 0.245 x 0.17 x 0.08
OLS449 <sup>1</sup>	1.2	1.7	1	1500	4000	65	–	1500	6L 0.17 x 0.245 x 0.08
OLS0449	1.2	1.7	1	1500	4000	65	0	1000	4L 0.225 x 0.155 x 0.75
OLF100	0.9	1.7	1	100	–	30	–	1000	6L 0.18 x 0.18 x 0.10
OLF249 <sup>1</sup>	1.3	1.8	1	200	1200	40	–	1000	8L 0.18 x 0.18 x 0.10
OLF449 <sup>1</sup>	1.2	1.7	1	1500	4000	65	–	1000	8L 0.18 x 0.18 x 0.10
OLH249 <sup>1</sup>	1.3	1.8	1	200	1200	40	–	1000	8L 0.39 x 0.32 x 0.15
OLH449	1.2	1.7	1	1500	4000	65	–	1000	6L 0.2 x 0.302 x 0.745
OLH1047 OLH1048 OLH1049	0.8	1.5	1	50/100/200	–/500/1000	40	–	1000	8L 0.39 x 0.32 x 0.15
4N47 4N48 4N49	0.8	1.5	1	50/100/200	–/500/1000	40	–	1000	6L 0.2 x 0.302 x 0.745
MCT4 MCT4R	–	1.5	10	15	–	30	–	1000	4L 0.22 x 0.185 x 0.69

### Dual-channel Photo-transistor Optocouplers

Part Number	$V_F$ (V) @ $I_F = 10$ mA		$I_F$ (mA)	CTR		$BV_{ce0}$ (V)	$V_{cc}$ Max. (V)	Isolation 25 °C $V_{DC}$ @ 1 s	Package Size (inch)
	Min.	Max.		Min. (%)	Max. (%)				
OLH2047 <sup>1</sup> OLH2048 <sup>1</sup> OLH2049 <sup>1</sup>	0.8	1.5	1	50/100/200	–/500/1000	40	–	2500	8L 0.39 x 0.32 x 0.15
OLS2249	1.2	1.8	1	200	1200	65	–	1500	8L 0.245 x 0.170 x 0.08
OLS2449	1.2	1.7	1	1500	4000	65	–	1500	8L 0.245 x 0.170 x 0.08

1. Radiation tolerant.  
2. No base connection.

## High Speed Optocouplers

High speed optocouplers are suitable for interfacing TTL to LSTTL, TTL, or CMOS as well as wide bandwidth analog applications. Each unit has a light emitting diode and an integrated photo-diode transistor detector mounted and coupled in a miniature custom substrate for hybrid assembly, or in hermetically sealed packages. The integrated photo-diode transistor improves switching speed by orders of magnitude as compared to standard photo transistors, by reducing the base to collector capacitance.

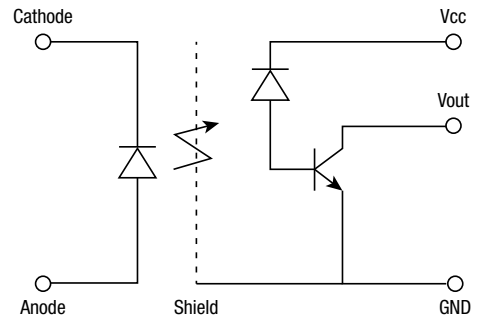

**High Speed Optocoupler  
Functional Schematic**

### Single-channel High Speed Optocouplers

Part Number	$V_F$ (V) @ $I_F = 10$ mA		CTR @ $I_F$ (mA)	CTR		Vcc Max. (V)	Isolation 25 °C $V_{DC}$ @ 1 s	Package Size (inch)
	Min.	Max.		Min. (%)	Max. (%)			
OLI300 <sup>1</sup>	–	2.5	10	15	–	18	1500	6L 0.1 x 0.11 x 0.65
OLS300 <sup>1</sup>	–	2.5	10	20	–	18	1500	6L 0.245 x 0.17 x 0.08
OLH300 <sup>1</sup>	–	2.5	10	20	–	18	1000	6L 0.2 x 0.302 x 0.745
OLF300 <sup>1</sup>	–	2.5	16	9	–	18	1000	8L 0.18 x 0.18 x 0.1
OLH5500 <sup>1</sup> OLH5501 <sup>1,2</sup>	–	2.5	16	12	–	18	3000	8L 0.39 x 0.32 x 0.15

### Dual-channel High Speed Optocouplers

Part Number	$V_F$ (V) @ $I_F = 10$ mA		CTR @ $I_F$ (mA)	CTR		Vcc Max. (V)	Isolation 25 °C $V_{DC}$ @ 1 s	Package Size (inch)
	Min.	Max.		Min. (%)	Max. (%)			
OLH5530 <sup>1</sup> OLH5531 <sup>1,3</sup>	–	2.5	16	12	–	18	3000	8L 0.39 x 0.32 x 0.15

### Wide-band Analog High Speed Optocouplers

Part Number	$V_F$ (V) @ $I_F = 10$ mA		CTR @ $I_F$ (mA)	CTR		Vcc Max. (V)	Isolation 25 °C $V_{DC}$ @ 1 s	Package Size (inch)
	Min.	Max.		Min. (%)	Max. (%)			
OLI303	–	2.5	5	20	80	18	1500	6L 0.1 x 0.11 x 0.65
OLS303	–	2.5	5	20	80	18	1500	6L 0.245 x 0.17 x 0.08

1. Radiation tolerant.

3. Screened per Isolink SB flow (similar to MIL-STD-883 Class B).

## Low Input Current Photodarlington Optocouplers

Low input current photodarlington optocouplers have high current transfer ratio at very low input currents making them ideal for applications such as MOS, CMOS, and low power logic interfacing or RS-232C data transmission systems. Each unit has a light emitting diode and an integrated photodiode-darlington detector IC mounted and coupled in a miniature custom substrate for hybrid assembly or in hermetically sealed packages. The darlington detector has an integrated base-emitter resistor for superior high temperature performance. The split darlington design permits lower output saturation voltage and higher switching speed operation than possible with conventional photodarlington design.

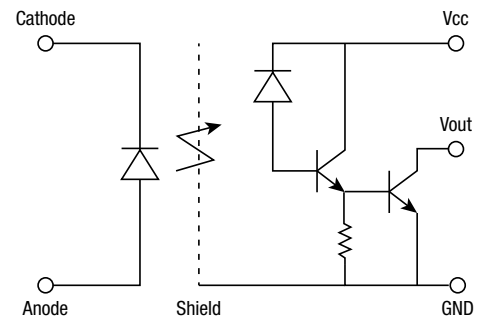

**Low Input Current Photodarlington Optocoupler Functional Schematic**

### Single-channel Low Input Current Photodarlington Optocouplers

Part Number	$V_F$ (V) @ $I_F = 10$ mA		CTR		$V_{CC}$ Max. (V)	Isolation 25 °C $V_{DC}$ @ 1 s	Package Size (inch)	
	Min.	Max.	@ $I_F$ (mA)	Min. (%)				Max. (%)
OLI400 <sup>1</sup>	–	2	0.5 / 5	300/200	–	20	1500	6L 0.1 x 0.11 x 0.65
OLS400 <sup>1</sup>	–	2	0.5 / 5	300/200	–	20	1500	8L 0.225 x 0.155 x 0.75
OLF400 <sup>1</sup>	–	2	0.5 / 5	300/200	–	20	1000	8L 0.18 x 0.18 x 0.1
OLH400 <sup>1</sup>	–	2	0.5 / 5	300/200	–	20	1000	6L 0.2 x 0.302 x 0.745
OLH5700 <sup>1</sup> OLH5701 <sup>1,3</sup>	1	2	0.5 / 5	300/200	–	18	3000	8L 0.39 x 0.32 x 0.15

### Dual-channel Low Input Current Photodarlington Optocouplers

Part Number	$V_F$ (V) @ $I_F = 10$ mA		CTR		$V_{CC}$ Max. (V)	Isolation 25 °C $V_{DC}$ @ 1 s	Package Size (inch)	
	Min.	Max.	@ $I_F$ (mA)	Min. (%)				Max. (%)
OLH5730 <sup>1</sup> OLH5731 <sup>1,3</sup>	1	2	0.5 / 5	300/200	–	18	3000	8L 0.39 x 0.32 x 0.15

## Schmitt Trigger Optocouplers

Schmitt trigger optocouplers have a light emitting diode and an integrated high-speed detector mounted and coupled in a miniature custom package. The light from the light emitting diode is collected by the photodiode in the integrated detector. The integrated detector incorporates a Schmitt trigger, which provides hysteresis for noise immunity and pulse shaping, and an open collector output. Typical propagation delay of this product is 170 ns. The common mode transient immunity is greater than 1000 V/  $\mu$ s.

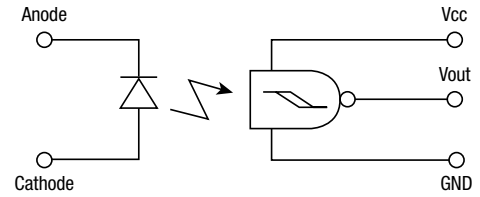

**Schmitt Trigger Optocoupler Functional Schematic**

### Single-channel Schmitt Trigger Optocouplers

Part Number	$V_F$ (V) @ $I_F = 10$ mA		Threshold Current $I_{F(ON)}$			Vcc Max. (V)	Isolation 25 °C $V_{DC}$ @ 1 s	Package Size (inch)
	Min.	Max.	Vcc (V)	Min. (mA)	Max. (mA)			
OLI600	–	2.4	15	–	10	18	1500	6L 0.1 x 0.11 x 0.65
OLS600	–	2.4	15	–	10	18	1500	6L 0.245 x 0.17 x 0.08
OLH6000 OLH6001 <sup>3</sup>	–	2.4	18	–	5	18	1500	8L 0.39 x 0.32 x 0.15

## High Speed Switching, High CMR, Logic Gate Optocouplers

High speed switching, high common mode rejection (CMR), logic gate optocouplers are suitable for high-speed digital interfacing applications, elimination of ground loops and input/output buffering. Each unit has a light emitting diode and an integrated high-speed detector mounted and coupled in a miniature custom ceramic package providing 1500 Vdc electrical isolation between input and output. The light from the light emitting diode is collected by the photodiode in the integrated detector and amplified by a high gain linear amplifier that drive a Schottky clamped open collector output transistor. Typical propagation delay of this product is 60 ns. The internal shield improves common mode transient immunity to 1000 V/  $\mu$ s minimum.

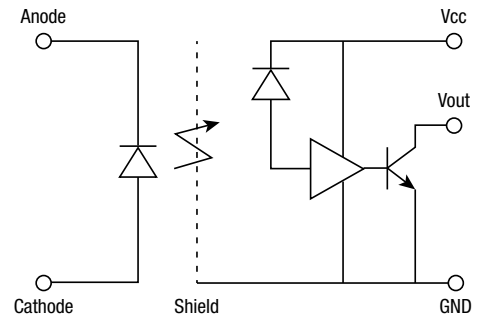

**High Speed Switching, High CMR, Logic Gate Optocoupler Functional Schematic**

### Single-channel High Speed Switching, High CMR, Logic Gate Optocouplers

Part Number	$V_F$ (V) @ $I_F = 10$ mA		VOL @ $I_F$ (mA)	VOL		Vcc Max. (V)	Isolation 25 °C $V_{DC}$ @ 1 s	Package Size (inch)
	Min.	Max.		Min. (V)	Max. (V)			
OLI500	–	2.5	5	–	0.6	7	1500	6L 0.1 x 0.11 x 0.65
OLI580	–	2.3	–	–	–	–	1500	6L 0.10 x 0.11 x 0.065
OLS500	–	2.5	5	–	0.6	7	1500	6L 0.245 x 0.17 x 0.08
OLF500	–	2.5	5	–	0.6	7	1000	8L 0.18 x 0.18 x 0.1
OLH500	–	2.5	5	–	0.6	7	1000	6L 0.39 x 0.32 x 0.15

3. Screened per Isolink SB flow (similar to MIL-STD-883 Class B).



## High Speed Switching, High CMR, Logic Gate Optocouplers

### Single-channel High Speed Switching, High CMR, Logic Gate Optocouplers

Part Number	$V_F$ (V) @ $I_F = 10$ mA		VOL			Vcc Max. (V)	Isolation 25 °C $V_{DC}$ @ 1 s	Package Size (inch)
	Min.	Max.	@ $I_F$ (mA)	Min. (V)	Max. (V)			
OLH5600 OLH5601	–	2.2	10	–	0.6	7	3000	8L 0.39 x 0.32 x 0.15
OLH5800 OLH5801 <sup>3</sup>	–	2.3	–	–	–	20	3000	8L 0.39 x 0.32 x 0.15

### Dual-channel High Speed Switching, High CMR, Logic Gate Optocouplers

Part Number	$V_F$ (V) @ $I_F = 10$ mA		VOL			Vcc Max. (V)	Isolation 25 °C $V_{DC}$ @ 1 s	Package Size (inch)
	Min.	Max.	@ $I_F$ (mA)	Min. (V)	Max. (V)			
OLH5630 OLH5631 <sup>3</sup>	–	2.5	10	–	0.6	7	3000	8L 0.39 x 0.32 x 0.15

## Linear Optocouplers

Linear optocouplers consist of one LED optically coupled to two matched photodiode detectors. Photodiode detectors are used for excellent linearity. The photodiode on the input side acts as a feedback device permitting an external feedback loop to ensure constant LED light output. A similar matching photodiode on the output side is used to drive an output circuit that is electrically isolated from the input. A fixed relationship is thus maintained between input and output.

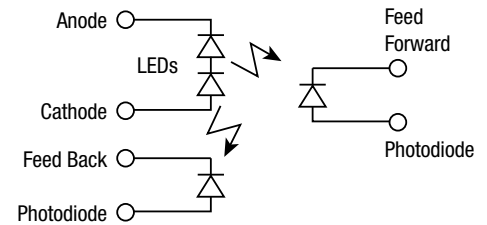

**Linear Optocoupler  
Functional Schematic**

### Single-channel

Part Number	$V_F$ (V) @ $I_F = 10$ mA		Coupled Characteristics			Transfer Gain	Isolation 25 °C $V_{DC}$ @ 1 s	Package Size (inch)
	Min.	Max.	$I_F$ (mA)	Servo Current $I_{P1}$ ( $\mu$ A)	Forward Current $I_{P2}$ (mA)			
OLS700	–	1.6	10	typ. 30	30	$1 \pm 0.25$	1000	6L 0.245 x 0.17 x 0.08
OLH7000	–	3.3	10	typ. 50	50	$1 \pm 0.25$	1000	8L 0.39 x 0.32 x 0.15

3. Screened per Isolink SB flow (similar to MIL-STD-883 Class B).

## Photovoltaic Optocouplers

Photovoltaic optocouplers consist of a pair of light emitting diodes optically coupled to a dielectrically isolated photovoltaic diode array. When the LED is energized, the infrared emission is detected by the photovoltaic array and a DC output voltage is generated. This electrically isolated voltage can be used to drive the gates of MOS devices.

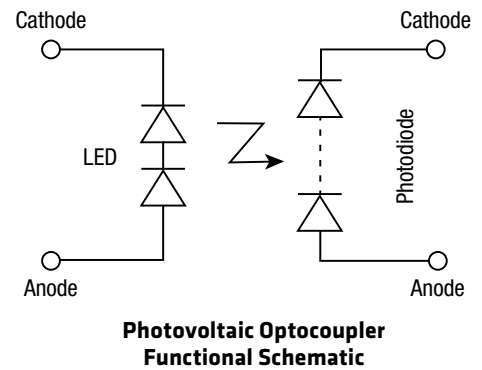

### Single-channel Photovoltaic Optocouplers

Part Number	$V_F$ (V) @ $I_F = 10$ mA		$I_{sc}$ @ $I_F$ (mA)	Conditions		$V_R$ (V)	Isolation 25 °C $V_{DC}$ @ 1 s	Package Size (inch)
	Min.	Max.		Min. ( $\mu$ A)	Max.			
OLI910	–	3.2	10	7	–	200	1500	4L 0.17 x 0.095 x 0.085
OLS910	–	3.2	10	7	–	200	1500	6L 0.245 x 0.17 x 0.08
OLH910	–	3.2	10	7	–	200	1500	8L 0.39 x 0.32 x 0.15

## Smart Photovoltaic Optocouplers

The OLI920 consists of a pair of LEDs that are optically coupled to a dielectrically isolated photovoltaic diode array, packaged on a thick film ceramic substrate. When the LED is energized, the infrared emission is detected by the photovoltaic array and a DC output voltage is generated. This electrically isolated voltage can be used to drive the gates of Metal Oxide Semiconductor (MOS) devices. Additional control circuitry provides fast turn-off, protection for false turn-on, and gate protection.

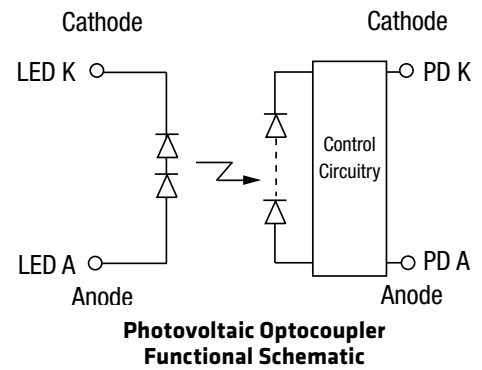

### Hybrid Smart Photovoltaic Optocoupler

Part Number	$V_F$ (V) @ $I_F = 10$ mA		$I_{sc}$ @ $I_F$ (mA)	Conditions		$T_{OFF}$ (15 pF)	Isolation 25 °C $V_{DC}$ @ 1 s	Package Size (inch)
	Min.	Max.		Min. ( $\mu$ A)	Max.			
OLI920	–	3.2	10	7	–	200	1500	4L 0.145 x 0.145 x 0.08

# Power Detection

Signal amplitudes or signal presence must be measured for proper operation of many systems. For example, the received signal strength is typically measured in a radio receiver in order to adjust automatic gain control circuits in order to maintain the desired output signal from the radio receiver. Many communications standards and legal regulations specify very tight requirements for the transmitted output power from a radio transmitter. Schottky detector diodes comprise the heart of these signal amplitude measurement systems.

The Schottky junction operates with majority carriers only—there are no minority carriers to slow the recovery time of the Schottky diode when a driving signal applied to the diode changes polarity from that which forward biases the diode to the opposite polarity. The Schottky diode's impedance changes virtually instantaneously with the change in polarity of the driving signal, thus enabling the Schottky to have very high rectification efficiency over a very wide frequency range.

Schottky detector diodes are available as beam lead, flip chip, unpackaged dice, in surface-mount plastic packages and in hermetic, ceramic packages.



Beam lead, flip chip and unpackaged die configurations offer optimal performance since there are no package parasitic reactances present in these configurations.

Plastic-packaged devices are readily surface mountable and present the lowest cost alternative of the available package styles. The parasitic impedances of these packages can reduce the maximum frequency of operation to an extent determined by the magnitude of these parasitic reactances.

Schottky diodes packaged in hermetic, ceramic packages can meet all requirements for high-reliability screening while operating to high frequency, since their parasitic reactances are relatively small.



















## Schottky Diodes—Low Frequency to 100 GHz

### Surface Mount Technology (SMT) Plastic and 0201 Chip Scale Package (CSP)—Low Frequency to 100 GHz

Base Part Number	Minimum Detectable Signal (dBm)	Barrier Height	Input Signal Frequency Range	Maximum Capacitance (pF)	Configuration
SMS7630 Series	-60	ZBD	Up to 10 GHz	0.30	Single Junction, Common Cathode Pair, and Series Pair
 SMS7630-061	-60	ZBD	Up to 100 GHz	0.30	Single Junction
SMS7621 Series	-53	Low	Up to 10 GHz	0.30	Single Junction, Common Cathode Pair, and Series Pair
 SMS7621-060	-53	Low	Up to 100 GHz	0.18	Single Junction

## Power Detection



















### Chip, Beam Lead and 0201 CSP—Low Frequency to 100 GHz

Base Part Number	Minimum Detectable Signal (dBm)	Barrier Height	Input Signal Frequency Range	Maximum Capacitance (pF)	Configuration
 CDC7630-000	-52	ZBD	–	0.25	Single junction
 DDC2353-000	-52	ZBD	Ku band	–	Single junction
 CDC7631-000	-56	ZBD	Ku band	0.15	Single junction
 DDC2354-000	-56	ZBD	Ku band	–	Single junction
 SMS7630-061	-60	ZBD	Up to 100 GHz	0.30	Single junction
 CDB7620-000	-50	Low	Ku band	0.15	Single junction
 CDF7621-000	-53	Low	Ku band	0.10	Single junction
 CDF7623-000	-53	Low	X band	0.30	Single junction
 SMS7621-060	-53	Low	Up to 100 GHz	0.18	Single junction
 DDB2503-000	-50	Medium	K band	0.10	Single junction
 DDB2504-000	-48	Medium	Ku band	0.10	Single junction
 DME2127-000	-47	Medium	S band	0.30–0.50	Single junction
 CDE7618-000	-45	Medium	K band	0.10	Single junction
 CME7660-000	-45	Medium	Ku band	0.15	Single junction
 DME2458-000	-45	Medium	K band	0.10	Single junction
 DME2333-000	-45	Medium	Ku band	0.05–0.15	Single junction
 DME2050-000	-45	Medium	S band	0.3–0.5	Series pair
 CDP7624-000	-40	High	X band	0.15	Single junction
 DDB2265-000	-40	High	X band	0.1	Single junction

Screened bare die, epoxy and ceramic hermetic packaged versions of these devices are available through Isolink (a wholly owned subsidiary of Skyworks Solutions, Inc.). For more information, please visit the Isolink website at [www.skyworksinc.com/Isolink](http://www.skyworksinc.com/Isolink).

## Power Detection

### Ceramic and Hermetic—Low Frequency to 40 GHz

Base Part Number	Minimum Detectable Signal (dBm)	Barrier Height	Input Signal Frequency Range	Maximum Capacitance (pF)	Configuration
 CDC7630	-52	ZBD	–	0.40	Single junction
 CDC7631	-56	ZBD	Ku band	0.35	Single junction
 CDB7619	-50	Low	Ku band	0.15	Single junction
 CDB7620	-50	Low	Ku band	0.35	Single junction
 CDF7621	-53	Low	Ku band	0.30	Single junction
 CDF7623	-53	Low	X band	0.50	Single junction
 DDC2353	-52	ZBD	Ku band	–	Single junction
 DDC2354	-56	ZBD	Ku band	–	Single junction
 DDB2503	-50	Medium	K band	0.25	Single junction
 DDB2504	-48	Medium	Ku band	0.20	Single junction
 DME2127	-47	Medium	S band	0.30–0.59	Single junction
 CDE7618	-45	Medium	K band	0.27	Single junction
 CME7660	-45	Medium	Ku band	0.4	Single junction
 DME2458	-45	Medium	K band	0.16	Single junction
 DME2333	-45	Medium	Ku band	0.05–0.24	Single junction
 DME2050	-45	Medium	S band	0.3–0.57	Series pair
 CDP7624	-40	High	X band	0.4	Single junction
 DDB2265	-40	High	X band	0.18	Single junction

Screened bare die, epoxy and ceramic hermetic packaged versions of these devices are available through Isolink (a wholly owned subsidiary of Skyworks Solutions, Inc.). For more information, please visit the Isolink website at [www.skyworksinc.com/Isolink](http://www.skyworksinc.com/Isolink).

# Power Management

Linear Voltage Regulator (PowerLinear™) products include MicroPower™, NanoPower™, and OmniPower™ LDO (Low Dropout) linear regulators which provide regulated power sources in products such as smart phones, PNDs, notebook computers, set-top boxes, digital still cameras, and other portable personal electronic devices. Skyworks' LDO regulator products are designed to provide a well regulated power supply while at the same time maximize the performance for a given application. NanoPower LDO regulators typically operate with a ground current level of 1.1  $\mu$ A. The MicroPower product line has LDO regulators optimized for low output noise and high power supply ripple rejection, making them well suited for sensitive RF and wireless circuit applications. Other MicroPower single- and dual-channel LDO regulators from Skyworks feature fast transient response to meet the most demanding load requirements. OmniPower LDO regulators are suitable for general purpose linear regulation requirements across a wide range of applications. All Skyworks LDO regulators are designed to be highly reliable and stable over a wide range of operating conditions. All LDO regulator devices function with a wide variety of input and output capacitor types. However, they are ideally suited for stability with ceramic capacitors. Low-cost ceramic capacitors are recommended to help increase circuit performance, reduce printed circuit board area, and minimize cost. To further enhance application reliability under adverse operating conditions, all PowerLinear LDO regulators include over-current and over-temperature protection circuits.

Skyworks' Power Half Bridges include MultiMHz power switches that can be used to provide compact voltage regulation in high-speed power supplies. Integrating input level shifting, high-speed break-before-make (shoot-through protection) circuitry, and low resistance, these power MOSFETs reduce board space, parts count, and stray parasitics in switching power supplies. FastSwitch™ buffered half bridge products may be used to drive inductors directly, as high-current gate drivers for discrete power MOSFETs. In addition, a dual buffered half-bridge may be used to drive multiple outputs or can be configured as a full bridge to affect a DC motor or Class-D audio driver.

Skyworks can supply devices in addition to the products shown to meet your power management requirements.

## Voltage Regulation

### Low Drop-Out (LDO) Linear Regulators

Part Number	Max. $I_{OUT}$ (mA)	Accuracy	Power Good	Shutdown	Typ. Dropout (mV)	$V_{OUT}$ (V)	VREF Bypass	$V_{IN}$ (V)	Typ. IQ ( $\mu$ A)	Package (mm)
 AAT3215	150	$\pm 1.5\%$	No	Yes	140	Fixed 2.5–3.3	Yes	$V_{OUT}-5.5$	95	SOT-23 5L 2.85 x 2.8 x 1.2

## Display and Lighting

### Panel Power

Part Number	Min. $V_{IN}$ (V)	Max. $V_{IN}$ (V)	Max. $I_{OUT}$ (mA)	Max. $V_{PDS}$ (mA)	Regulated Outputs (Number)	Max. $V_{NEC}$	$V_{REF}$	Switching Frequency (kHz)	Max. Shutdown Current ( $\mu$ A)	Typ. $I_Q$ ( $\mu$ A)	Package (mm)
 AAT2823	2.5	5.5	20	30	4	-30	N/A	1300	1	1100	TQFN 24L 4 x 4 x 0.75

# Receiver Protection

The receiver protector function is performed by a specially processed PIN diode, known as a limiter diode. The PIN limiter diode can be described as an incident-power-controlled, variable resistor. In receiver protection systems, the PIN limiter diode is placed in shunt with the main signal path. In the case when no large input signal is present, the impedance of the limiter diode is at its maximum, thereby producing minimum insertion loss, typically less than 0.5 dB. The presence of a large input signal temporarily forces the impedance of the diode to a much lower value, producing an impedance mismatch which reflects the majority of the input signal power back towards its source.

The input power level at which the limiter diode's impedance starts to decrease in response to a large input signal amplitude is primarily determined by the diode's I layer thickness. The diodes which "turn on" at the lowest signal levels have the thinnest I layers.

PIN limiter diodes are available unpackaged dice, in surface-mount plastic packages and in hermetic, ceramic packages.



Unpackaged die configurations offer optimal performance since there are no package parasitic reactances present in these configurations.

Plastic-packaged devices are readily surface mountable and present the lowest cost alternative of the available package styles. The parasitic impedances of these packages can reduce the maximum frequency of operation to an extent determined by the magnitude of these parasitic reactances.

PIN limiter diodes packaged in hermetic, ceramic packages can meet all requirements for high-reliability screening while operating to high frequency, since their parasitic reactances are relatively small.

## Limiter Diodes

### Plastic Surface Mount (SMT) Limiter Diodes—Low Frequency to 6 GHz

Part Number	$V_B$ $I_R = 10 \mu A$ (V)	Nominal I-Region Thickness ( $\mu m$ )	$C_T$ 0 V, F = 1 MHz (pF)	Typ. $C_T$ 0 V F = 1 GHz (pF)	$R_S$ $I_F = 10$ mA F = 100 MHz ( $\Omega$ )	Typ. Carrier Lifetime $T_L$ $I_F = 10$ mA (ns)	Package (mm)
 SMP1330-005LF	20–50	3	0.7 Typ., 1.0 Max.	0.7	1.25 Typ., 1.5 Max.	4	SOT-23 3L 2.37 x 2.92 x 1
 SMP1330-040LF	20–50	2	0.7 Typ., 1.0 Max.	0.7	1.25 Typ., 1.5 Max.	4	SOD-882 2L (0402) 1 x 0.6 x 0.46
 SMP1330-085LF	20–50	3	0.7 Typ., 1.0 Max.	0.7	1.25 Typ., 1.5 Max.	4	QFN 3L 2 x 2 x 0.9

## Receiver Protection

### High Power Surface Mount Technology (SMT) Limiter Diodes

Part Number	$V_B I_R = 10 \mu A$ (V)	I Region Thickness ( $\mu m$ ) Nominal	Typ. $C_T$ (pF) 0 V, F = 1 MHz	$C_T$ (pF) 0 V, F = 1 GHz	Max. $C_T$ (pF) 6 V, F = 1 MHz	$C_T$ (pF) 30 V, F = 1 MHz	Max. $R_S$ $I_F = 10$ mA F = 100 MHz ( $\Omega$ )	Typ. Carrier Lifetime $T_L$ (ns) $I_F = 10$ mA	Package (mm)
CLA4603-085LF	20–45	t	0.36	–	0.40	0.32 Typ.	2.0	10	QFN 3L 2 x 2 x 0.9
CLA4605-085LF	30–60	2	0.33	–	–	0.30 Typ.	2.0	7.0	QFN 3L 2 x 2 x 0.9
CLA4606-085LF	45–75	2.5	0.32	–	0.38	0.29 Typ.	2.0	10	QFN 3L 2 x 2 x 0.9
CLA4607-085LF	180 Min.	7	0.40	–	–	0.30 Typ.	2.0	50	QFN 3L 2 x 2 x 0.9
CLA4608-085LF	120–180	7	–	–	–	0.65 Max.	1.2	100	QFN 3L 2 x 2 x 0.9
CLA4609-086LF	250 Min.	28	–	–	–	0.60 Max.	1.5	1.1	QFN 3L 2 x 2 x 0.9
CLA4610-085LF	80–120	4.5	0.13	–	0.12	–	2.2	20	QFN 3L 2 x 2 x 0.9
CLA4611-086LF	120–180	12	0.2	–	0.65 @ 50 V	–	1.2	450	QFN 3L 2 x 2 x 0.9

### Silicon Limiter Diode Chips for High Performance—Low Frequency to 36 GHz

#### Limiter Performance

Part Number	Threshold Level (dBm)	I Layer Thickness ( $\mu m$ )	Insertion Loss at -10 dBm & 10 GHz (dB)	Maximum Junction Capacitance (pF)	Maximum CW Input Power (dBm)	Maximum Peak Input Power (dBm)
CLA4601-000	7	1.0	0.1	0.10	33.0	47
CLA4602-000	7	1.0	0.1	0.15	34.8	50
CLA4603-000	10	1.5	0.1	0.15	33.0	50
CLA4604-000	12	2.0	0.1	0.10	34.8	47
CLA4605-000	12	2.0	0.1	0.15	36.0	50
CLA4606-000	15	2.5	0.1	0.15	34.8	53
CLA4607-000	20	7.0	0.1	0.15	37.8	60
CLA4608-000	20	7.0	0.2	0.5	41.7	66
CLA4609-000	38	28.0	0.3	0.14	43.0	70
CLA4610-000	22	4.5	0.1	0.12	40.0	57
CLA4611-000	25	12	0.3	0.20	40.0	60

Screened bare die, epoxy and ceramic hermetic packaged versions of these devices are available through Isolink (a wholly owned subsidiary of Skyworks Solutions, Inc.). For more information, please visit the Isolink website at [www.skyworksinc.com/Isolink](http://www.skyworksinc.com/Isolink).



## Receiver Protection

### Silicon Limiter Diode Chips for High Performance—Low Frequency to 36 GHz (Continued)

#### Electrical Characteristics

Part Number	$V_B$ @ 10 $\mu$ A (V)	Typ. $C_j$ @ 0 V (pF)	Max. $C_j$ @ 6 V (pF)	Max. $R_s$ @ 10 mA ( $\Omega$ )	Max. $T_L$ @ 10 mA (ns)	Thermal Impedance	
						Max. Average (C/W)	Typ. 1 $\mu$ s Pulse (C/W)
CLA4601-000	15–30	0.12	0.10	2.5	5	120	15
CLA4602-000	15–30	0.20	0.15	2.0	5	80	10
CLA4603-000	20–45	0.20	0.15	2.0	5	100	10
CLA4604-000	30–60	0.12	0.10	2.5	7	100	10
CLA4605-000	30–60	0.20	0.15	2.0	7	70	7.0
CLA4606-000	45–75	0.20	0.15	2.0	10	80	7.0
CLA4607-000	120–180	0.20	0.15 @ 50 V	2.0	50	40	1.2
CLA4608-000	120–180	0.80	0.5 @ 50 V	1.2	100	15	0.3
CLA4609-000	250 (Min.)	0.26	0.14	1.5	1175	15	0.3
CLA4610-000	80–120	0.13	0.12	2.2	20	72	72
<b>CLA4611-000</b>	120–180	0.20	0.65 @ 50 V	1.2	450	15	2

Screened bare die, epoxy and ceramic hermetic packaged versions of these devices are available through Isolink (a wholly owned subsidiary of Skyworks Solutions, Inc.). For more information, please visit the Isolink website at [www.skyworksinc.com/Isolink](http://www.skyworksinc.com/Isolink).

#### Hermetic Packaged Silicon Limiter Diodes

Hermetic Stripline 240	Hermetic Pill 203	Hermetic Pill 219	Hermetic Pill 210
CLA4601-240	CLA4601-203	CLA4601-219	CLA4601-210
CLA4602-240	CLA4602-203	CLA4602-219	CLA4602-210
CLA4603-240	CLA4603-203	CLA4603-219	CLA4603-210
CLA4604-240	CLA4604-203	CLA4604-219	CLA4604-210
CLA4605-240	CLA4605-203	CLA4605-219	CLA4605-210
CLA4606-240	CLA4606-203	CLA4606-219	CLA4606-210
CLA4607-240	CLA4607-203	CLA4607-219	CLA4607-210
CLA4608-240	CLA4608-203	CLA4608-219	CLA4608-210
CLA4609-240	CLA4609-203	CLA4609-219	CLA4609-210
CLA4610-240	CLA4610-203	CLA4610-219	CLA4610-210
<b>CLA4611-240</b>	<b>CLA4611-203</b>	<b>CLA4611-219</b>	<b>CLA4611-210</b>

Screened bare die, epoxy and ceramic hermetic packaged versions of these devices are available through Isolink (a wholly owned subsidiary of Skyworks Solutions, Inc.). For more information, please visit the Isolink website at [www.skyworksinc.com/Isolink](http://www.skyworksinc.com/Isolink).

# Limiter Modules

## Integrated Single-Stage PIN Diode Limiter

Part Number	RF Test Freq. (GHz)	Typ. Insertion Loss (dB) $P_{IN} = 0$ dBm	Typ. Return Loss (dB) $P_{IN} = 0$ dBm	Typ. Threshold Level (dBm)	Maximum Saturated Power (Watts)	Typ. Flat Leakage Power (dBm) $P_{IN} = 10$ dBm ( $P_{IN} = 20$ dBm)	Package (mm)
 SKY16601-555LF	2.5	0.1	27.5	11	29	13	MLP 2L 2.5 x 2.5 x 0.75

# Switching

RF microwave switching with semiconductors can be accomplished with PIN diodes and with transistor structures, such as pseudomorphic high electron mobility transistors (pHEMT). Switches comprising these types of semiconductors have relative advantages with respect to each other. Skyworks can supply devices in addition to the products shown to meet your switching requirements.

## Switch Technology Advantages

Attribute	Silicon PIN Diode	GaAs pHEMT Switch
Power Handling	Very High (To Greater than 1 kW CW)	Moderate (Up to 10 W CW)
Switching Time	A Few Tens of Nanoseconds to Several Microseconds	Tens to a Few Hundreds of Nanoseconds
Control Current	Up to 100 Milliamps	Less than 100 Microamps
Distortion Performance	Input Third Order Intercepts in the 45 dBm or Higher Range	Input Third Order Intercepts in the 30 to Low 40s dBm Range
“Integratability” with Other Components	Moderate	Excellent

## Switching Silicon PIN Diodes

### Plastic Surface Mount (SMT) PIN Diodes—Low Frequency to 6 GHz

Part Number	Min. $V_B$ $I_r = 10$ $\mu$ A (V)	Max. $C_T$ $V_R = 30$ V $F = 1$ MHz (pF)	Typ. $V_F$ @ $I_F = 10$ mA (V)	Typ. $R_S$ $I_F = 1$ mA $F = 100$ MHz ( $\Omega$ )	Max. $R_S$ $I_F = 10$ mA $F = 100$ MHz ( $\Omega$ )	Typ. $T_L$ $I_F = 10$ mA (ns)	Nominal I-Region Thickness ( $\mu$ m)
SMP1320 Series	50	0.3	0.85	2	0.9	400	8

### Low Capacitance Switching PIN Diodes—Low Frequency to 6 GHz

Part Number	Min. $V_B$ $I_r = 10$ $\mu$ A (V)	Max. $C_T$ $V_R = 30$ V $F = 1$ MHz (pF)	Typ. $V_F$ @ $I_F = 10$ mA (V)	Typ. $R_S$ $I_F = 1$ mA $F = 100$ MHz ( $\Omega$ )	Max. $R_S$ $I_F = 10$ mA $F = 100$ MHz ( $\Omega$ )	Typ. $T_L$ $I_F = 10$ mA (ns)	Nominal I-Region Thickness ( $\mu$ m)
SMP1321 Series	100	0.25	0.85	3	2	400	15

## Switching Silicon PIN Diodes

### Low Capacitance, Fast Switching PIN Diodes—Low Frequency to 6 GHz

Part Number	Min. $V_B$ $I_R = 10 \mu\text{A}$ (V)	Max. $C_T$ $V_R = 5 \text{ V}$ $F = 1 \text{ MHz}$ (pF)	Typ. $V_F$ @ $I_F = 10 \text{ mA}$ (V)	Typ. $R_S$ $I_F = 1 \text{ mA}$ $F = 100 \text{ MHz}$ ( $\Omega$ )	Max. $R_S$ $I_F = 10 \text{ mA}$ $F = 100 \text{ MHz}$ ( $\Omega$ )	Typ. $T_L$ $I_F = 10 \text{ mA}$ (ns)	Nominal I-Region Thickness ( $\mu\text{m}$ )
SMP1340 Series	50	0.3	0.88	1.7	1.2	100	7

### Lowest Capacitance Switching PIN Diodes for High Isolation—Low Frequency to 6 GHz

Part Number	Min. $V_B$ $I_R = 10 \mu\text{A}$ (V)	Max. $C_T$ $V_R = 20 \text{ V}$ $F = 1 \text{ MHz}$ (pF)	Typ. $V_F$ @ $I_F = 10 \text{ mA}$ (V)	Typ. $R_S$ $I_F = 1 \text{ mA}$ $F = 100 \text{ MHz}$ ( $\Omega$ )	Max. $R_S$ $I_F = 10 \text{ mA}$ $F = 100 \text{ MHz}$ ( $\Omega$ )	Typ. $T_L$ $I_F = 10 \text{ mA}$ (ns)	Nominal I-Region Thickness ( $\mu\text{m}$ )
SMP1345 Series	50	0.2	0.89	3.5	2	100	10

### Low Capacitance Switching PIN Diodes—Low Frequency to 10 GHz

Part Number	Min. $V_B$ $I_R = 10 \mu\text{A}$ (V)	Max. $C_T$ $V_R = 30 \text{ V}$ $F = 1 \text{ MHz}$ (pF)	Typ. $V_F$ @ $I_F = 10 \text{ mA}$ (V)	Typ. $R_S$ $I_F = 100 \text{ MHz}$ ( $\Omega$ )	Max. $R_S$ $I_F = 100 \text{ MHz}$ ( $\Omega$ )	Typ. $T_L$ $I_F = 10 \text{ mA}$ (ns)	Nominal I-Region Thickness ( $\mu\text{m}$ )
SMP1331 Series	200	0.35	0.8	12.5	2.0	600	30

### AEC-Q101 Qualified<sup>2</sup>

Part Number	Min. $V_B$ $I_R = 10 \mu\text{A}$ (V)	Max. $C_T$ $V_R = 30 \text{ V}$ (pF)	Typ. $V_F$ $I_F = 10 \text{ mA}$ (V)	$R_S$ $I_F = 1 \text{ mA}$ $F = 100 \text{ MHz}$ ( $\Omega$ )	Max. $R_S$ $I_F = 10 \text{ mA}$ $F = 100 \text{ MHz}$ ( $\Omega$ )	Max. $R_S$ $I_F = 100 \text{ mA}$ $F = 100 \text{ MHz}$ ( $\Omega$ )	Typ. Carrier Lifetime $I_F = 10 \text{ mA}$ (ns)	Package (mm)
SMPA1302-079LF	200	0.3	0.80	20 Max.	3.0	1.5	700	QFN 2L 2 x 2 x 0.9
SMPA1320-079LF	50	0.3	0.85	2 Typ.	0.9	–	400	QFN 2L 2 x 2 x 0.2

2. Not all stresses listed within AEC-Q101 have been performed. Qualification report available upon request.

Contact your sales representative for more information. For the full details of Skyworks Quality and Reliability on our products that can be designed into automotive applications, please view the "Skyworks Quality Standards for Automotive Customers" on our website.

### Large Signal Switching PIN Diodes—Low Frequency to 6 GHz

Part Number	Min. $V_B$ $I_R = 10 \mu\text{A}$ (V)	Max. $C_T$ $V_R = 20 \text{ V}$ $F = 1 \text{ MHz}$ (pF)	Typ. $V_F$ @ $I_F = 10 \text{ mA}$ (V)	Max. $R_S$ $I_F = 1 \text{ mA}$ $F = 100 \text{ MHz}$ ( $\Omega$ )	Max. $R_S$ $I_F = 10 \text{ mA}$ $F = 100 \text{ MHz}$ ( $\Omega$ )	Typ. $T_L$ $I_F = 10 \text{ mA}$ (ns)	Nominal I-Region Thickness ( $\mu\text{m}$ )
SMP1352 Series	200	0.35	0.8	15	2.8	1000	50

## Switching Silicon PIN Diodes

### PIN Diodes—High Power (>20 W) for Large Signal Switch and Attenuator Applications

Part Number	Min. $V_B$ $I_R = 10 \mu A$ (V)	Max. $C_T$ $V_R = 20 V$ $F = 1 MHz$ (pF)	Typ. $C_T$ $V_R = 30 V$ $F = 1 MHz$ (pF)	Max. $V_F$ $@ I_F = 50 mA$ (V)	Max. $R_s$ $F = 100 MHz$ ( $\Omega$ )	Min. $T_L$ $I_F = 10 mA$ (ns)	Nominal I-Region Thickness ( $\mu m$ )	Package (mm)
SMP1302-085LF	200	–	0.30	0.8 @ 10 mA	3.0 @ 10 mA	700	50	QFN 3L 2 x 2 x 1
SMP1304-085LF	200	–	0.23	1.0	7.0 @ 10 mA	1000 Typ.	100	QFN 2L 2 x 2 x 0.9
SMP1304-087LF	200	–	0.20	1.0	7.0 @ 10 mA	1000 Typ.	100	QFN 2L 2 x 2 x 0.9
SMP1324-087LF	100	–	0.90	0.9 Typ.	0.40 Typ. @ 50 mA	6000 Typ.	100	QFN 2L 2 x 2 x 0.9
SMP1325-085LF	200	0.65	–	0.86 Typ.	1.3 Typ. @ 10 mA	5000 Typ.	100	QFN 3L 2 x 2 x 1
SMP1325-087LF	200	0.6	–	0.8 Typ.	1.3 Typ. @ 10 mA	5000 Typ.	100	QFN 2L 2 x 2 x 0.9
SMP1331-085LF	200	–	0.26	0.8 Typ.	1.7 Typ. @ 10 mA	600 Typ.	30	QFN 2L 2 x 2 x 0.9
SMP1331-087LF	200	–	0.26	0.8 Typ.	1.7 Typ. @ 10 mA	600 Typ.	30	QFN 2L 2 x 2 x 0.9
SMP1345-087LF	50	0.2 @ 5 V	–	0.89	2.0 @ 10 mA	100 Typ.	10	QFN 2L 2 x 2 x 0.9
SMP1371-087LF	35	1.2	–	1.0	0.5 @ 10 mA	200	12	QFN 2L 2 x 2 x 0.9

### Chip PIN Diodes—Low Frequency to 36 GHz

Part Number	$V_B$ @ 10 $\mu A$ (V)	Nominal I-Region ( $\mu m$ )	Typ. $C_J$ @ 0 V (pF)	Max. $C_J$ @ 50 V (pF)	Max. $R_s$ @ 10 mA ( $\Omega$ )	Max. $T_L$ @ 10 mA (ns)	Max. Thermal Resistance (C/W)
APD0505-000	50	5	0.10	0.05	2.0	20	100
APD0510-000	50	5	0.20	0.10	1.5	40	80
APD0520-000	50	5	0.25	0.20	1.0	50	80
APD0805-000	100	8	0.10	0.05	2.0	100	80
APD0810-000	100	8	0.15	0.10	1.5	160	60
APD1505-000	50	15	0.12	0.6 @ 10 V	2.5	350	60
APD1510-000	200	15	0.20	0.10	2.0	300	60
APD1520-000	200	15	0.25	0.20	1.2	900	30
APD2220-000	100	50	0.2	0.2	4	700	80





































Screened bare die, epoxy and ceramic hermetic packaged versions of these devices are available through Isolink (a wholly owned subsidiary of Skyworks Solutions, Inc.). For more information, please visit the Isolink website at [www.skyworksinc.com/Isolink](http://www.skyworksinc.com/Isolink).

### Beam-Lead PIN Diodes—Low Frequency to 40 GHz

Part Number	$V_B$ @ 10 $\mu A$ (V)	Max. $C_J$ @ 10 V (pF)	Max. $C_J$ @ 50 V (pF)	Max. $R_s$ @ 10 mA ( $\Omega$ )	Typ. $T_L$ @ 10 mA (ns)
DSM8100-000	60	0.025	–	3.5	25
DSG9500-000	100	–	0.025	4.0 @ 50 mA	250

## Switching Silicon PIN Diodes

















### Ceramic Hermetic Packaged General-Purpose PIN Diodes for Switching and Attenuator Applications—Low Frequency to 20 GHz

Hermetic Stripline 240	Hermetic Pill 203	Hermetic Pill 210	Hermetic Pill 219
 APD0505-240	 APD0505-203	 APD0505-210	 APD0505-219
 APD0510-240	 APD0510-203	 APD0510-210	 APD0510-219
 APD0520-240	 APD0520-203	 APD0520-210	 APD0520-219
 APD0805-240	 APD0805-203	 APD0805-210	 APD0805-219
 APD0810-240	 APD0810-203	 APD0810-210	 APD0810-219
 APD1505-240	 APD1505-203	 APD1505-210	 APD1505-219
 APD1510-240	 APD1510-203	 APD1510-210	 APD1510-219
 APD1520-240	 APD1520-203	 APD1520-210	 APD1520-219
 APD2220-240	 APD2220-203	 APD2220-210	 APD2220-219

Screened bare die, epoxy and ceramic hermetic packaged versions of these devices are available through Isolink (a wholly owned subsidiary of Skyworks Solutions, Inc.). For more information, please visit the Isolink website at [www.skyworksinc.com/Isolink](http://www.skyworksinc.com/Isolink).

## FET Switches

### UHF/VHF Broadband Switches—Low Frequency to 6 GHz









Part Number	Description	Frequency (GHz)	Insertion Loss (dB)	Isolation (dB)	Input IP3 (dBm)	Input P <sub>1dB</sub> (dBm)
 SKY13286-359LF	SPDT (A)	0.10–6.0	0.8–1.5	62–42	46	30
 SKY13348-374LF	SPDT (A)	0.50–6.0	0.6–1.0	27–24	57	37
 SKY13370-374LF	SPDT (A)	0.50–6.0	0.7–1.15	31–24	55	39
 AS179-92LF	SPDT (R)	0.02–3.0	0.4	23	43	30
 AS193-73LF	SPDT (R)	0.10–2.5	0.55	17	55	37
 SKY13270-92LF	SPDT (R)	0.02–2.5	0.3–0.55	30–17	56	38
 SKY13290-313LF	SPDT (R)	0.02–2.5	0.3	44	65	39
 SKY13298-360LF	SPDT (R)	3.0–8.0	0.7–0.9	25–22	47	26
 SKY13299-321LF	SPDT (R)	0.02–6.0	0.3	42	65	38
 SKY13351-378LF	SPDT (R)	0.02–6.0	0.35	24	50	30 (0.5 dB)
 SKY13317-373LF	SP3T (R)	0.02–6.0	0.6	25	50	29
 SKY13385-460LF	SP3T (R)	0.10–3.5	0.5–0.6	39–25	57	33
 SKY13322-375LF	SP4T (R)	0.02–6.0	0.6	26	51	30
 SKY13318-321LF	DPDT (R)	0.10–6.0	0.95	22	57	34
 <b>SKY13355-374LF</b>	DPDT (R)	0.10–6.0	0.6	23.5	55	33
 <b>SKY13381-374LF</b>	DPDT (R)	0.10–6.0	0.6	22	62	38

## Switching

### SPDT (SP2T) RF Switches

Part Number	Description (Absorptive/ Reflective)	Min. Frequency (GHz)	Max. Frequency (GHz)	Typ. IL (dB)	Typ. Isol. (dB)	Typ. IIP3 (dBm)	Typ. IP <sub>1dB</sub> (dBm)	Package (mm)
 SKY13330-397LF	SPDT (R)	0.1	6	0.3–0.55	35–16	55	39	QFN 12L 2 x 2 x 0.55

### High Power (50 W, 100 W) SPDT PIN Diode Switches

Part Number	Description (Absorptive/ Reflective)	Frequency (GHz)	Typ. IL (dB)	Typ. Isol. (dB)	Typ. IIP3 (dBm)	Max. CW Power (dBm)	Package (mm)
 SKY12207-306LF	SPDT (R)	0.9–4.0	0.3–0.6	28–41	78	50	QFN 16L 4 x 4 x 0.9
 SKY12207-478LF	SPDT (R)	0.9–4.0	0.3–0.4	30–42	78	50	QFN 16L 4 x 4 x 1.5
 SKY12208-306LF	SPDT (R)	0.02–2.7	0.1–0.4	33–49	76	50	QFN 16L 4 x 4 x 0.9
 SKY12208-478LF	SPDT (R)	0.02–2.7	0.1–0.4	33–49	76	50	QFN 16L 4 x 4 x 1.5
 SKY12209-478LF	SPDT (R)	0.9–4.0	0.4–0.65	35–42	76	40	QFN 16L 4 x 4 x 1.5
 SKY12210-478LF	SPDT (R)	0.9–4.0	0.3–0.6	33–44	78	100	QFN 16L 4 x 4 x 1.5
 SKY12211-478LF	SPDT (R)	0.05–2.7	0.2–0.5	33–52	76	40	QFN 16L 4 x 4 x 1.5
 SKY12212-478LF	SPDT (R)	0.02–2.7	0.3–0.6	32–50	68	100	QFN 16L 4 x 4 x 1.5

## Switching

### DC to 6 GHz Hermetic GaAs IC SPST Non-Reflective Switch

The ISO13316 is a GaAs pHEMT non-reflective, high-performance, low-loss switch. The device uses hermetic surface-mount technology (SMT) for defense and satellite applications. The ISO13316 can be supplied and tested to the screening requirements of MIL-PRF-38535 Class B and S, in addition to the required Quality Conformance Inspection (QCI).

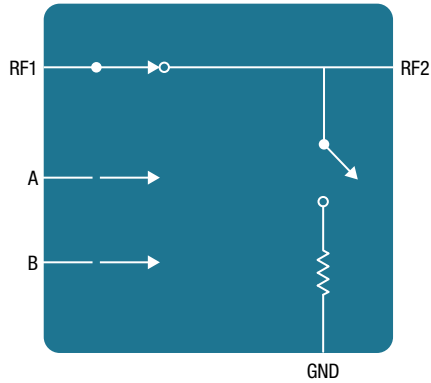

Functional Diagram

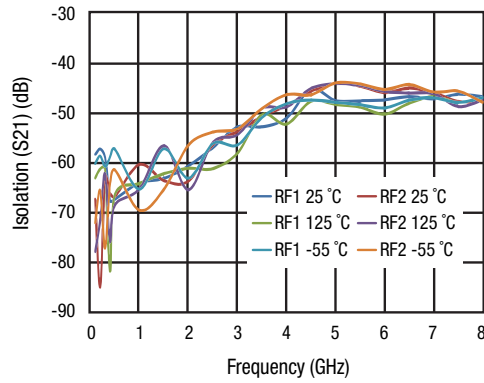

Isolation vs. Frequency

Part Number	Input Power (dBm)	Isolation (dB)	Insertion Loss (dB)	Typ. Return Loss (dB)	Typ. Switching Time (ns)	Packaging (Inches)
ISO13316	Up to 25	50 @ 2 GHz 38 @ 4 GHz 27 @ 6 GHz	0.08 @ 6 GHz	50 @ 2 GHz 38 @ 4 GHz 27 @ 6 GHz	15	Hermetic SMT 0.385 x 0.345 x 0.065

### DC to 8 GHz Hermetic GaAs IC SPDT Absorptive Switch

The ISO13286 is a GaAs pHEMT non-reflective, high-performance, low-loss switch. The ISO13286 uses hermetic surface-mount technology (SMT) for defense and satellite applications. The device can be supplied and tested to the screening requirements of MIL-PRF-38535 Class B and S, in addition to the required QCI.

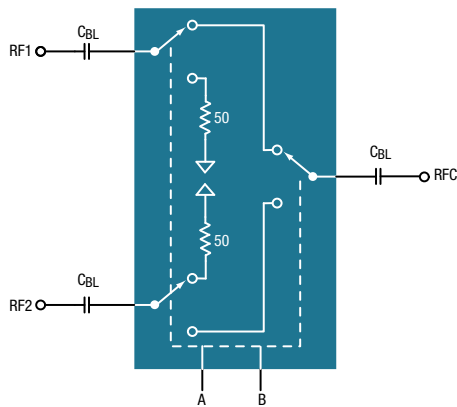

Functional Diagram

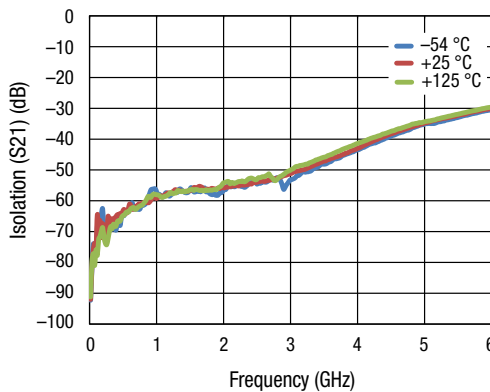

Isolation vs. Frequency

Part Number	Input Power (dBm)	Isolation (dB)	Insertion Loss (dB)	Typ. Return Loss (dB)	Typ. Switching Time (ns)	Packaging (Inches)
ISO13286	Up to 25	50 @ 2 GHz 45 @ 4 GHz 40 @ 6 GHz 40 @ 8 GHz	3 @ 8 GHz	24 @ 2 GHz 20 @ 4 GHz 12 @ 6 GHz 10 @ 8 GHz	15	Hermetic SMT 0.385 x 0.345 x 0.065

# Tuning

Tuning varactor (TVAR) diodes are used to electronically tune frequencies and phase of the signal generation in local oscillators, using variable reactance. Tuning varactors may be an abrupt junction device, which can produce a capacitance ratio of approximately 3:1 over the tuning voltage range 0 to 30 V, or a hyperabrupt junction device, which can produce capacitance ratios of 10:1 or greater over the tuning voltage range of 0 to 10 V.

In hyperabrupt TVARs, there is an artifact of the ability to produce large capacitance ratios: larger series resistance. Some hyperabrupt tuning varactors might produce 3 Ω or 4 Ω series resistance, compared to 0.5 Ω or less for an abrupt junction device. This larger series resistance means that the wide bandwidth capability of the hyperabrupt TVAR must be weighed against its higher resistive loss and somewhat higher phase noise production as compared to an abrupt junction TVAR. Figures 2 and 3 show the Skyworks' TVAR product offering sorted by capacitance as measured with  $V_R = 3$  V, along with the maximum rated capacitance ratio for each product. Figures 4 and 5 show these same data, but sorted by maximum rated capacitance ratio.

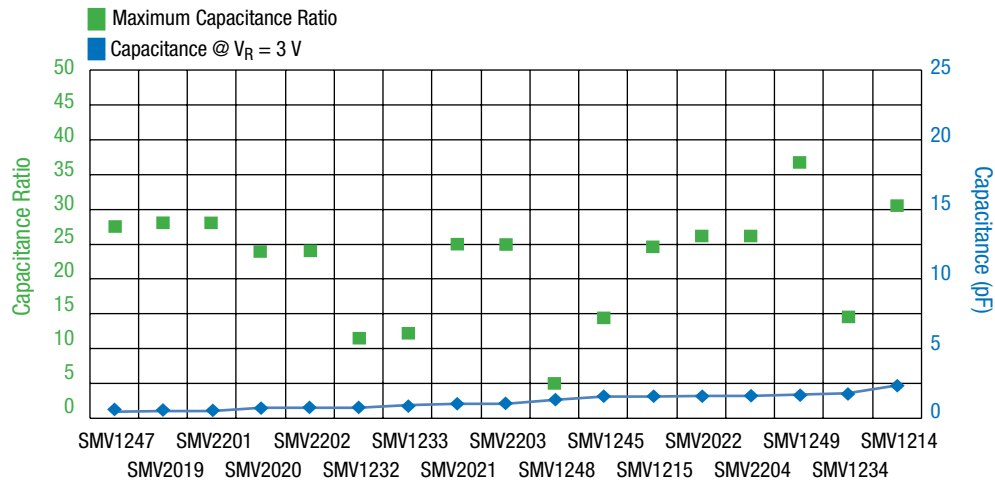

**Figure 2. Skyworks Solutions Tuning Varactors Sorted by Capacitance at  $V_R = 3$  V**

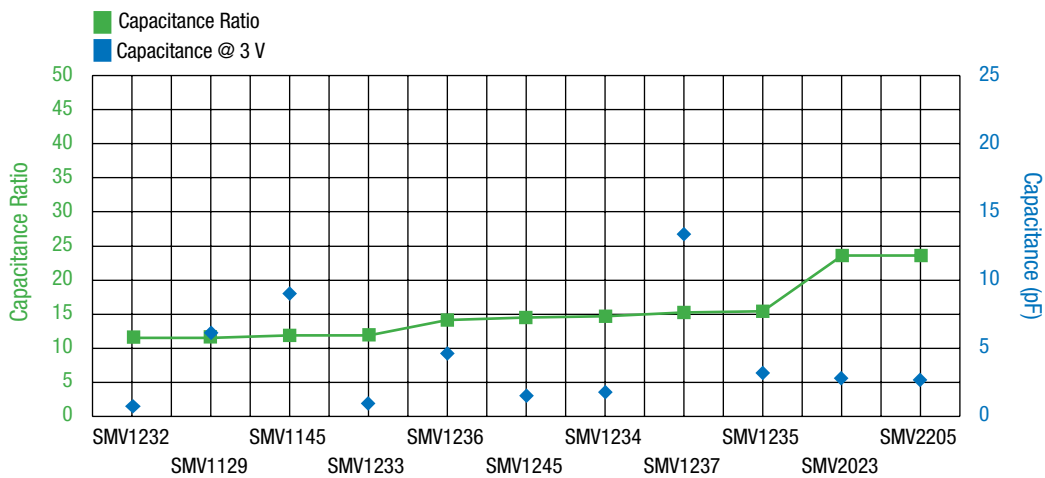

**Figure 3. Skyworks Solutions Tuning Varactors Sorted by Capacitance at  $V_R = 3$  V**



# Tuning

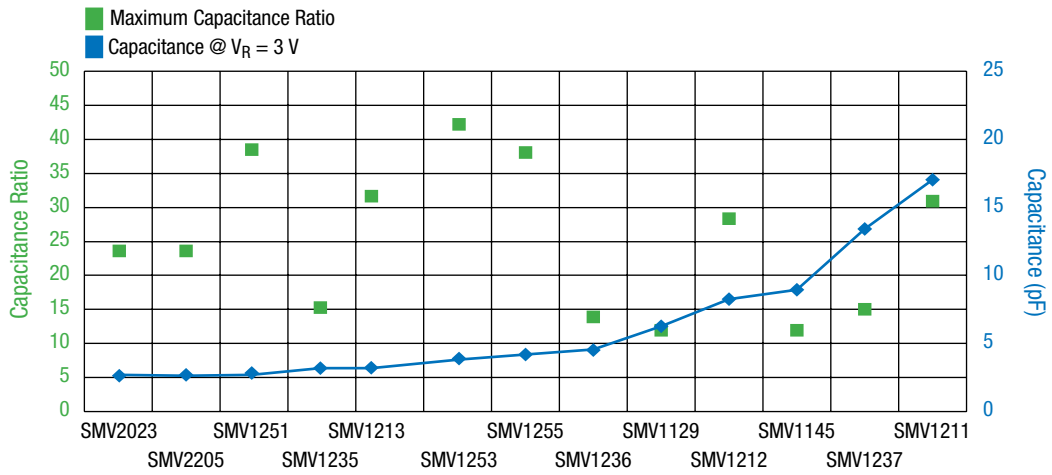

Figure 4. Skyworks Solutions Tuning Varactors Sorted by Maximum Rated Capacitance Ratio

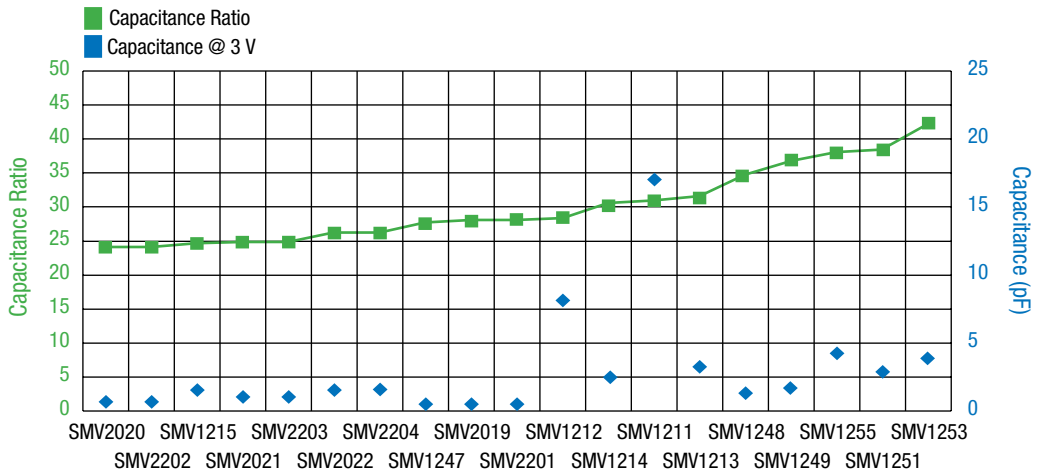

Figure 5. Skyworks Solutions Tuning Varactors Sorted by Maximum Rated Capacitance Ratio

# Application Notes

See the table below for a list of Application Notes. Please visit our website to access our technical documents, which include application notes and product briefs.

Category	Description	Document Numbers
Amplifiers	Gain Block Bias Networks	200942
Amplifiers (LNA)	SKY65047-360LF Matching Circuits for Various Frequency Bands	201100
Amplifiers (LNA)	SKY65050-372LF: Low Noise Amplifier Operation	200975
Circulators and Isolators	Curie Temperature of Isolators and Circulators	201659
Circulators and Isolators	Factors That Influence the Power Handling Capability of Circulators	201543
Circulators and Isolators	How to Test Drop-In Circulators and Isolators	201539
Circulators and Isolators	Performance of Radar Circulators under Peak and Average Power Conditions	201660
Circulators and Isolators	Reliability Performance for Standard Commercial Ferrite Isolators and Circulators	201540
General	Circuit Models for Plastic Packaged Microwave Diodes	200311
General	Diode Chips, Beam-Lead Diodes, Capacitors: Bonding Methods and Packaging	200532
General	Quality/Reliability	200149
General	Solder Reflow Information	200164
General	Waffle Pack Chip Carrier Handling/Opening Procedure	200146
Limiter	PIN Limiter Diodes in Receiver Protectors	200480
Phase Shifter	A Varactor Controlled Phase Shifter for PCS Base Station Applications	200319
PIN Diodes	5–6 GHz Switch Using Low-Cost Plastic Packaged PIN Diodes	200321
PIN Diodes	A Wideband CATV Attenuator	200327
PIN Diodes	A Wideband General-Purpose PIN Diode Attenuator	200313
PIN Diodes	Design With PIN Diodes	200312
PIN Diodes	PIN Diode Basics	200823
PIN Diodes	T/R Switch for IMT-2000 Handset Applications	200318
Schottky Diodes	Handling Precautions for Schottky Barrier Mixer and Detector Diodes	200840
Schottky Diodes	Level Detector Design for Dual-Band GSM-PCS Handsets	200324
Schottky Diodes	Mixer and Detector Diodes	200826
Tuning Varactor	A Balanced Wideband VCO for Set-Top TV Tuner Applications	200314
Tuning Varactor	A Colpitts VCO for Wideband (0.95–2.15 GHz) Set-Top TV Tuner Applications	200316
Tuning Varactor	Differential VCO Design for GSM Handset Applications	200323
Tuning Varactor	Dual-Band Switchable IF VCO for GSM/PCS Handsets	200325
Tuning Varactor	Low Phase Noise VCO Design for PCS Handset Applications	200326
Tuning Varactor	Switchable Dual-Band 170/420 MHz VCO for Handset Cellular Applications	200317
Tuning Varactor	Varactor Diodes	200824
Tuning Varactor	Varactor SPICE Models for RF VCO Applications	200315
Tuning Varactor	VCO Designs for Wireless Handset and CATV Set-Top Applications	200322
Tuning Varactor	VCO Design for WLAN Applications in the 2.4–2.5 GHz ISM Band	200320

## Published Articles

- PIN Diodes for High Power T/R Switches
- A High Linearity Darlington Intermediate Frequency (IF) Amplifier for Wide Bandwidth Applications
- Distributed Switch FET Model that Predicts Better Insertion Loss and Harmonics
- Phase Locked Loop Systems Design for Wireless Infrastructure Applications
- Modeling of SOI FET for RF Switch Applications
- Make Accurate Sub-1 dB Noise Figure Measurements. Part 1: Noise Concepts
- Make Accurate Sub-1 dB Noise Figure Measurements. Part 2: The Measurements
- Effect of Permittivity and Permeability of a Flexible Magnetic Composite Material on the Performance and Miniaturization Capability of Planar Antennas for RFID and Wearable Wireless Applications
- RF/Microwave Solid State Switches: Part 1
- Solid State RF/Microwave Switch Technology: Part 2
- The Nuts and Bolts of Tuning Varactors
- Schottky Diodes

## Additional Literature

### Brochure

- RF Diode Design Guide, BR0389

### White Papers

- Designing Ultra Low Noise Amplifiers for Infrastructure Receiver Applications
- Skyworks De-embedded Scattering Parameters

### Learn More

For a complete listing of Skyworks' published articles, white papers, application notes and technical documents, please visit our website at [www.skyworksinc.com](http://www.skyworksinc.com).

### Product Documents

## Designer Kits

### Quickly Convert Your Creativity into Working Designs

Skyworks' Designer Kits feature samples of a variety of leading-edge components, with data sheets and comprehensive application notes supplied on CD.

- KIT601 MIS Chip Capacitors for Hybrid Circuit Applications
- KIT603 Silicon PIN Diode Chips for Switch and Attenuator Applications
- KIT606 Silicon Limiter Diode Chips
- KIT607 Silicon Schottky Diode Chips for Mixer and Detector Applications
- KIT613 RF Switches and Digital Attenuators for WLAN, Infrastructure and General Purpose Applications
- KIT614 Diodes (SMT Limiter, PIN, Schottky, Varactor)
- KIT619 Fixed Attenuator Pads (ATN3590)

# How to Select Diode Packages

Skyworks Solutions, Inc. produces standard die, plastic packaged, surface mount technology (SMT), and wafer on film frame diode products.

Isolink (a wholly owned subsidiary of Skyworks) produces epoxy and ceramic hermetic packaged diodes. Upscreened versions are also available for packaged and bare die devices. For more information, please visit the Isolink website at [www.skyworksinc.com/Isolink](http://www.skyworksinc.com/Isolink).



## Plastic Surface Mount Technology Packages

Plastic surface mount technology (SMT) packages are inexpensive and are compatible with modern pick-and-place assembly techniques, so they are optimal choices for high-volume, low-cost final product assemblies.

While careful attention has been paid to minimizing package parasitic reactances, they are always present in such diode configurations. These parasitics, package capacitance and package inductance, inherently reduce the bandwidth over which a diode may be used. Plastic SMT packages also add thermal resistance to that of the die, thereby reducing the amount of power a diode can dissipate without exceeding its maximum rated operating junction temperature.

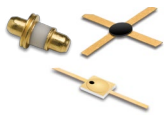

## Ceramic-Metal Packages

Ceramic-metal packages offer several advantages over plastic packages: their parasitic inductances and capacitances are lower, sometimes as much as 75% lower, than that of the plastic SMT packages described above. Their thermal resistances are also much lower than that of the large majority of plastic SMT packages. Most ceramic packages used for diodes are capable of being hermetically sealed, thereby offering maximum protection to the die against environmental contaminants such as sodium (Na), water vapor, etc.

Such packages have two disadvantages compared to plastic SMT packages: they are typically more costly, and, they generally are not compatible with automated surface mount assembly.

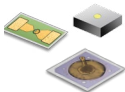

## (Packageless) Dice

Diode dice, sometimes known as chips, eliminate the parasitic reactances and thermal resistance of the package. This configuration produces the widest bandwidth of operation as well as maximal power dissipation capabilities.

Of course, the end user of diode dice must be capable of handling these tiny devices as well as performing die attach and wire bonding assembly techniques. The assemblies which contain dice must be protected from mechanical damage, especially to the fragile bond wires. Some devices are also available on film frame.



## Beam-Lead Power Handling Diodes

Beam-lead diodes offer the highest frequency performance capability, due to the absence of a package and its associated parasitic reactances, and the reduction of series inductance that would be presented by a bond wire. Also, since no mechanical connection needs to be made to the terminals of the diode junction by the user, the diode junction area can be very small, thus reducing junction capacitance.

The metal beams of beam-lead diodes must be mechanically and electrically attached to the circuit in which they are used. This lead attach may be accomplished using thermocompression bonding or a combination of thermocompression and ultrasonic bonding referred to as “thermalsonic bonding,” or beam attach may be done using conductive epoxy. Such assembly techniques are most frequently performed manually by skilled assemblers.

The only conduction paths for heat to flow out of the diode junction are through the metal beams, which have very small cross-sectional areas, so thermal resistance of beam-lead diodes is generally greater than 125 °C/W, sometimes substantially so. This limits the power dissipation of beam-lead diodes to relatively low power levels.

# Packaging







Skyworks' products are available in the packages shown in the table below. Please refer to individual data sheets for the availability of specific diode package combinations.

## Package Selection Guide

Part Number Suffix	Package Type	Actual Size	Package Dimensions (mm) (Lead Inclusive)*
-040	SOD-882 2L (0402)		1.00 x 0.60 x 0.46
-378, -385	MLPD 6-Pin		1.00 x 1.00 x 0.45
-203	Hermetic Pill		1.27 x 1.40
-517	MIS		1.47 x 1.23 x 0.70
-21	MCM		1.50 x 1.50 x 0.45
-373	QFN 8L		1.50 x 1.50 x 0.45
-079	SC-79		1.60 x 0.80 x 0.60
-219	Hermetic SMT		1.91 x 1.91 x 1.14
-396	QFN 8L		2.00 x 2.00 x 0.75
-085	QFN 2L (2 x 2) 1.7 mm Paddle		2.00 x 2.00 x 0.90
-086	QFN 2L (2 x 2) 1.7 mm Paddle		2.00 x 2.00 x 0.90
-087	QFN 2L (2 x 2)		2.00 x 2.00 x 0.90
-372	SC-70 4L		2.00 x 2.00 x 1.10
-375	QFN 10L		2.00 x 3.00 x 0.45
-313	QFN 6L		2.00 x 3.00 x 1.00
-92, -081	SC-88 (SC-70 6L)		2.10 x 2.00 x 0.95
-073, -074, -075, -076	SC-70		2.10 x 2.00 x 0.95
-377	QFN 4L		2.20 x 2.00 x 1.35
-001, -003, -004, -005, -006, -39	SOT-23 3L		2.37 x 2.92 x 1.00
-011	SOD-323		2.52 x 1.25 x 1.04
-027, -72	SOT-23 5L		2.80 x 2.90 x 1.18
-73	SOT-23 6L		2.80 x 2.90 x 1.18
-321, -348, -350	QFN (3 x 3)		3.00 x 3.00 x 0.75
-337	QFN 12L		3.00 x 3.00 x 0.90
-340	QFN 20L (4 x 4) 2.1 mm Paddle		4.00 x 4.00 x 0.75
-306	QFN 16L (4 x 4)		4.00 x 4.00 x 0.90
-355, -359, -467	QFN 16L (4 x 4)		4.00 x 4.00 x 0.90
-362, -459	QFN 24L		4.00 x 4.00 x 0.90
-478	QFN 16L (4 x 4)		4.00 x 4.00 x 1.50

Part Number Suffix	Package Type	Actual Size	Package Dimensions (mm) (Lead Inclusive)*
-86	MSOP 10L		4.90 x 3.00 x 0.96
-302, -303	MSOP 8L Exposed Pad		4.90 x 3.00 x 1.10 (Max.)
-364	QFN 32L 3.15 mm Paddle		5.00 x 5.00 x 0.90
-310	QFN 32L (5 x 5) 3.3 mm Paddle		5.00 x 5.00 x 0.90
N/A	32 Pin RFLGA		5.00 x 5.00 x 1.00
-207	Hermetic Ceramic Pill		5.08 x 2.18
-210	Hermetic Pill		5.7 x 3.15
-230	Epoxy Stripline		5.98 x 1.4 x 0.76
-232	Epoxy Stripline		5.98 x 3.69 x 0.76
-234, -235	Epoxy Stripline		5.98 x 5.98 x 0.76
-12	SOIC 8L		6.00 x 4.90 x 1.60
-80	SSOP 16L		6.00 x 4.90 x 1.60
N/A	36 Pin MCM		6.00 x 6.00 x 1.35
-87	TSSOP 16L		6.40 x 5.00 x 1.00
N/A	MCM 12L		7.00 x 7.00 x 1.10
-250, -251	Epoxy Stripline		8.12 x 2.54 x 1.27
-252, -253	Epoxy Stripline		8.12 x 5.33 x 1.27
-254	Epoxy Stripline		8.12 x 8.12 x 1.27
-255, -257	Epoxy Stripline		8.12 x 8.12 x 1.27
N/A	MCM 12L		8.385 x 8.385 x 1.35
-25	SOIC 16L		10.00 x 6.00 x 1.70

## Packaging

Part Number Suffix	Package Type	Actual Size	Package Dimensions (mm) (Lead Inclusive)*
-220, -221	Hermetic Stripline		11.3 x 1.91 x 1.14
-224	Hermetic Stripline		11.3 x 11.3 x 1.14
-225	Hermetic Stripline		11.3 x 11.3 x 1.14
-222	Hermetic Stripline		11.3 x 6.6 x 1.14
-223	Hermetic Stripline		11.3 x 6.6 x 1.14
-240	Hermetic Stripline		11.52 x 2.64 x 1.18

Package Type	Actual Size	Package Dimension (inch)
6-Lead Ceramic Carrier Chip for Hybrid Assembly		0.1 x 0.11 x 0.65
4-Lead Ceramic Carrier Chip for Hybrid Assembly		0.170 x 0.095 x 0.085
8-Lead Hermetic Ceramic Flat		0.18 x 0.18 x 0.10
4-Lead Hermetic TO-72		0.22 x 0.185 x 0.69
6-Lead Hermetic TO-5		0.200 x 0.302 x 0.745
6-Lead Hermetic Ceramic LCC		0.245 x 0.170 x 0.08
8-Lead Hermetic Ceramic LCC		0.245 x 0.170 x 0.08
8-Lead Hermetic Dip		0.39 x 0.32 x 0.15

\*Dimensions indicated: lead tip to lead tip x body width x total thickness.

Screened bare die, epoxy and ceramic hermetic packaged versions of these devices are available through Isolink (a wholly owned subsidiary of Skyworks Solutions, Inc.). For more information, please visit the Isolink website at [www.skyworksinc.com/Isolink](http://www.skyworksinc.com/Isolink).

Copyright © 2011, 2012, 2013, 2014, 2015, 2016 Skyworks Solutions, Inc.  
All Rights Reserved.

Information in this document is provided in connection with Skyworks Solutions, Inc. ("Skyworks") products or services. These materials, including the information contained herein, are provided by Skyworks as a service to its customers and may be used for informational purposes only by the customer. Skyworks assumes no responsibility for errors or omissions in these materials or the information contained herein. Skyworks may change its documentation, products, services, specifications or product descriptions at any time, without notice. Skyworks makes no commitment to update the materials or information and shall have no responsibility whatsoever for conflicts, incompatibilities, or other difficulties arising from any future changes.

No license, whether express, implied, by estoppel or otherwise, is granted to any intellectual property rights by this document. Skyworks assumes no liability for any materials, products or information provided hereunder, including the sale, distribution, reproduction or use of Skyworks products, information or materials, except as may be provided in Skyworks Terms and Conditions of Sale.

THE MATERIALS, PRODUCTS AND INFORMATION ARE PROVIDED "AS IS" WITHOUT WARRANTY OF ANY KIND, WHETHER EXPRESS, IMPLIED, STATUTORY, OR OTHERWISE, INCLUDING FITNESS FOR A PARTICULAR PURPOSE OR USE, MERCHANTABILITY, PERFORMANCE, QUALITY OR NON-INFRINGEMENT OF ANY INTELLECTUAL PROPERTY RIGHT; ALL SUCH WARRANTIES ARE HEREBY EXPRESSLY DISCLAIMED. SKYWORKS DOES NOT WARRANT THE ACCURACY OR COMPLETENESS OF THE INFORMATION, TEXT, GRAPHICS OR OTHER ITEMS CONTAINED WITHIN THESE MATERIALS. SKYWORKS SHALL NOT BE LIABLE FOR ANY DAMAGES, INCLUDING BUT NOT LIMITED TO ANY SPECIAL, INDIRECT, INCIDENTAL, STATUTORY, OR CONSEQUENTIAL DAMAGES, INCLUDING WITHOUT LIMITATION, LOST REVENUES OR LOST PROFITS THAT MAY

RESULT FROM THE USE OF THE MATERIALS OR INFORMATION, WHETHER OR NOT THE RECIPIENT OF MATERIALS HAS BEEN ADVISED OF THE POSSIBILITY OF SUCH DAMAGE.

Skyworks products are not intended for use in medical, lifesaving or life-sustaining applications, or other equipment in which the failure of the Skyworks products could lead to personal injury, death, physical or environmental damage. Skyworks customers using or selling Skyworks products for use in such applications do so at their own risk and agree to fully indemnify Skyworks for any damages resulting from such improper use or sale.

Customers are responsible for their products and applications using Skyworks products, which may deviate from published specifications as a result of design defects, errors, or operation of products outside of published parameters or design specifications. Customers should include design and operating safeguards to minimize these and other risks. Skyworks assumes no liability for applications assistance, customer product design, or damage to any equipment resulting from the use of Skyworks products outside of stated published specifications or parameters.

Skyworks, the Skyworks symbol, "Breakthrough Simplicity," FastSwitch, Green, Green Initiative, HIP3, Innovation to Go, Isolink, MicroPower, NanoPower, OmniPower, and PowerLinear are trademarks or registered trademarks of Skyworks Solutions, Inc., in the United States and other countries. Third-party brands and names are for identification purposes only, and are the property of their respective owners. Additional information, including relevant terms and conditions, posted at [www.skyworksin.com](http://www.skyworksin.com), are incorporated by reference.





## Skyworks Sales Offices

### USA

#### Headquarters: Massachusetts

Skyworks Solutions  
20 Sylvan Road  
Woburn, MA 01801  
Telephone: (781) 376-3000  
Fax: (781) 376-3100  
sales@skyworksinc.com

#### California

Skyworks Solutions  
5221 California Avenue  
Irvine, CA 92617  
Telephone: (949) 231-3000  
Fax: (949) 231-3206  
sales@skyworksinc.com

Skyworks Solutions  
2740 Zanker Road  
San Jose, CA 95134  
Telephone: (408) 232-2900  
Fax: (408) 232-2902  
sales@skyworksinc.com

#### Maryland

Skyworks Solutions  
5520 Adamstown Road  
Adamstown, MD 21710  
Telephone: (301) 695-9400  
Fax: (301) 695-7065  
transtech@skyworksinc.com

### EUROPE

#### France

Skyworks Solutions  
60 rue Saint André des Arts  
Bâtiment D  
75006 Paris  
France  
Telephone: +33 1 43548540  
Fax: +33 1 43540005  
irene.pfeiffer@skyworksinc.com

#### United Kingdom

Skyworks Solutions  
Ground Floor, Riverside House  
Riverside  
Bishop's Stortford  
Herts CM23 3AJ  
United Kingdom  
Telephone: +44 7920 838883  
will.kerley@skyworksinc.com

#### Finland

Skyworks Solutions  
Keilaranta 16 (5th Floor)  
FIN-02150 Espoo  
Finland  
Telephone: +358 9251 07131  
Fax: +358 9 2510 7129  
tommi.hiillos@skyworksinc.com

### ASIA • PACIFIC

#### China

Skyworks Solutions  
Unit 1201-1203 and 1206, Bldg# A,  
No. 868 Yinghua Road  
Pudong, Shanghai, China, PRC  
Telephone: +86 21 23066230  
ext. 60167  
Fax: +86 21 33663398  
elaine.zhao@skyworksinc.com

Skyworks Solutions  
Room 2701, 27/F Tower 3  
Kerry Plaza  
No. 1 Zhongxinsi Road  
Futian District  
Shenzhen 518048 China PRC  
Telephone: +86 755 8828 8399  
Fax: +86 755 8828 8358  
jesse.li@skyworksinc.com

Skyworks Solutions  
Suite 1315, Tower B, COFCO Plaza, No. 8  
Jianguomennei Avenue  
Dongcheng District  
Beijing 100005 China PRC  
Telephone: +8610 652 60859  
ext. 61602  
Fax: +8610 652 61358  
abby.huang@skyworksinc.com

#### Japan

Skyworks Solutions  
Tokyo Opera City Tower 36F  
3-20-2 Nishi-Shinjuku  
Shinjuku-ku  
Tokyo, 163-1436  
Japan  
Telephone: +81 3 5308 5180  
Fax: +81 3 5308 5190  
ahihiro.karikomi@skyworksinc.com

#### Korea

Skyworks Solutions  
POSCO Center (West Wing 12F)  
440 Taeheran-ro, Gangnam-ku  
Seoul, 06194, Korea  
Telephone: +82 2 3490 3800  
Fax: +82 2 553 5459  
juhee.lee@skyworksinc.com

#### Singapore

Skyworks Solutions  
10 Ang Mo Kio Street 65  
#05-15/16 Techpoint  
Singapore 569059  
Telephone: +65 64031971  
Fax: +65 64031931  
yuenfong.choong@skyworksinc.com

#### Taiwan

Skyworks Solutions  
4 F, #198, Section 2  
Tun Hwa S. Road  
Taipei 106, Taiwan ROC  
Telephone: +8862 5559 8992  
Fax: +8662 2735 6508  
joanna.wu@skyworksinc.com