



## SPECIFICATION FOR APPROVAL

Customer \_\_\_\_\_

Description DC FAN

Customer P/N: \_\_\_\_\_ REV. \_\_\_\_\_

Delta Model No. THA0412BN REV. 00

Sample Issue No. \_\_\_\_\_

Sample Issue Date MAY.10.2011

PLEASE SEND ONE COPY OF THIS SPECIFICATION BACK  
AFTER YOU SIGNED APPROVAL FOR PRODUCTION PRE-  
ARRANGMENT.

APPROVED BY: \_\_\_\_\_

DATE : \_\_\_\_\_

DELTA ELECTRONICS, INC.  
TAOYUAN PLANT  
252, SHANG YING ROAD, KUEI SAN INDUSTRIAL ZONE TAOYUAN  
SHIEN, TAIWAN, R.O.C.  
TEL:886-(0)3-3591968  
FAX:886-(0)3-3591991

DELTA ELECTRONICS, INC.  
 252, SHANG YING ROAD, KUEI SAN  
 TAOYUAN HSIEN 333, TAIWAN, R. O. C.

TEL : 886-(0)3-3591968  
 FAX : 886-(0)3-3591991

**SPECIFICATION FOR APPROVAL**  
 \*\*\*\*\*

Customer:

-----  
 Description: DC FAN  
 -----

Customer P/N: REV:

Delta Model NO.: THA0412BN

Sample Rev: 00 Issue NO:

Sample Issue Date: MAY.10.2011 Quantity:

1. SCOPE:

THIS SPECIFICATION DEFINES THE ELECTRICAL AND MECHANICAL CHARACTERISTICS OF THE DC BRUSHLESS AXIAL FLOW FAN. THE FAN MOTOR IS WITH SINGLE PHASE AND EIGHT POLES.

2. CHARACTERS:

ITEM	DESCRIPTION
RATED VOLTAGE	12 VDC
OPERATION VOLTAGE	7.0 - 13.2 VDC
INPUT CURRENT	0.89 (MAX. 1.32) A
INPUT POWER	10.68 (MAX. 15.84) W
SPEED	19000 R.P.M. (REF.)
MAX. AIR FLOW (AT ZERO STATIC PRESSURE)	0.83 (MIN. 0.75) M <sup>3</sup> /MIN. 29.52 (MIN. 26.56 ) CFM
MAX. AIR PRESSURE (AT ZERO AIRFLOW)	61.06 (MIN. 54.95) mmH <sub>2</sub> O 2.40 (MIN. 2.16 ) inchH <sub>2</sub> O
ACOUSTICAL NOISE (AVG.)	59.0 ( MAX. 63.0 ) dB-A
INSULATION TYPE	UL:CLASS A

(continued)

PART NO:

DELTA MODEL: THA0412BN

INSULATION STRENGTH	10 MEG OHM MIN. AT 500 VDC (BETWEEN FRAME AND (+) TERMINAL)
DIELECTRIC STRENGTH	5 mA MAX. AT 500 VAC 50/60 Hz ONE MINUTE, (BETWEEN FRAME AND (+) TERMINAL)
EXTERNAL COVER	OPEN TYPE
LIFE EXPECTANCE	70000 HOURS CONTINUOUS OPERATION AT 40 °C WITH 15 ~ 65 %RH.
ROTATION	CLOCKWISE VIEW FROM NAME PLATE SIDE
LEAD WIRE	UL 1061 -F- AWG #26 BLACK WIRE NEGATIVE(-) RED WIRE POSITIVE(+) BLUE WIRE FREQUENCY(-F00) YELLOW WIRE SPEED CONTROL(PWM)

- NOTES:
1. ALL READINGS ARE MEASURED AFTER STABLY WARMING UP THROUGH 10 MINUTES.
  2. THE VALUES WRITTEN IN PARENS , ( ), ARE LIMITED SPEC.
  3. THE CHARACTERS SHOWED IN PAGE 1 IS THE CONDITION OF BOTH FANS RUN.
  4. ACOUSTICAL NOISE MEASURING CONDITION:

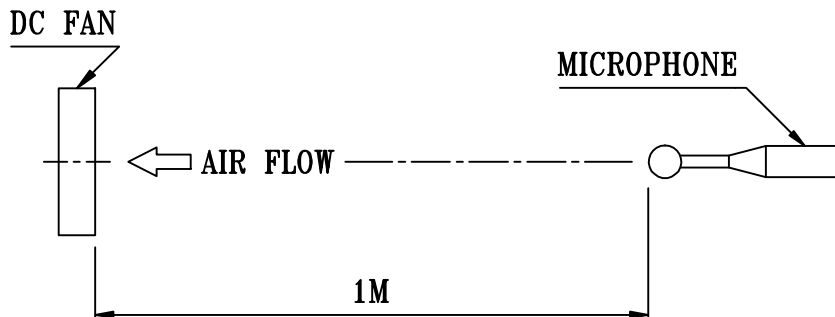

NOISE IS MEASURED AT RATED VOLTAGE IN FREE AIR IN ANECHOIC CHAMBER WITH B & K SOUND LEVEL METER WITH MICROPHONE AT A DISTANCE OF ONE METER FROM THE FAN INTAKE.

-----  
PART NO:  
-----

DELTA MODEL:       THA0412BN  
-----

3. MECHANICAL:

- 3-1. DIMENSIONS ----- SEE DIMENSIONS DRAWING
- 3-2. FRAME ----- DIE-CASTING ALUMINUM
- 3-3. IMPELLER ----- PLASTIC UL: 94V-0
- 3-4. BEARING SYSTEM ----- TWO BALL BEARINGS
- 3-5. WEIGHT ----- 46 GRAMS

4. ENVIRONMENTAL:

- 4-1. OPERATING TEMPERATURE ----- -10 TO +70 DEGREE C
- 4-2. STORAGE TEMPERATURE ----- -40 TO +75 DEGREE C
- 4-3. OPERATING HUMIDITY ----- 5 TO 90 % RH
- 4-4. STORAGE HUMIDITY ----- 5 TO 95 % RH

5. PROTECTION:

5-1. LOCKED ROTOR PROTECTION

IMPEDANCE OF MOTOR WINDING PROTECTS MOTOR FROM FIRE IN 96 HOURS OF LOCKED ROTOR CONDITION AT THE RATED VOLTAGE.

5-2. POLARITY PROTECTION

BE CAPABLE OF WITHSTANDING IF REVERSE CONNECTION FOR POSITIVE AND NEGATIVE LEADS.

6. RE OZONE DEPLETING SUBSTANCES:

- 6-1. NO CONTAINING PBBs, PBBOs, CFCs, PBBEs, PBDPEs AND HCFCs.

7. PRODUCTION LOCATION

- 7-1. PRODUCTS WILL BE PRODUCED IN CHINA OR THAILAND OR TAIWAN.

-----  
PART NO:  
-----

DELTA MODEL:   THA0412BN  
-----

8. BASIC RELIABILITY REQUIREMENT :

8-1. THERMAL       LOW TEMPERATURE: -40°C  
CYCLING           HIGH TEMPERATURE: +80°C  
                    SOAK TIME: 30 MINUTES  
                    TRANSITION TIME < 5 MINUTES  
                    DUTY CYCLES: 5

8-2. HUMIDITY      TEMPERATURE: +25°C ~ +65°C  
EXPOSURE          HUMIDITY: 90-98% RH @ +65°C  
                    FOR 4 HOURS/CYCLE  
                    POWER: NON-OPERATING  
                    TEST TIME: 168 HOURS

8-3. VIBRATION     TEMPERATURE: +25°C  
                    ORIENTATION: X, Y, Z  
                    POWER: NON-OPERATING  
                    VIBRATION LEVEL: OVERALL  $g_{RMS}=3.2$

FREQUENCY(Hz)	PSD( $G^2/Hz$ )
10	0.040
20	0.100
40	0.100
800	0.002
1000	0.002

TEST TIME: 2 HOURS ON EACH ORIENTATION

8-4. MECHANICAL   TEMPERATURE: +20°C  
SHOCK             ORIENTATION: X, Y, Z  
                    POWER: NON-OPERATING  
                    ACCELERATION: 20 G MIN.  
                    PULSE: 11 ms HALF-SINE WAVE  
                    NUMBER OF SHOCKS: 5 SHOCKS  
  FOR EACH DIRECTION

8-5. LIFE           TEMPERATURE: MAX , OPERATING TEMPERATURE  
                    POWER: OPERATING  
                    DURATION: 1000 HOURS MIN.

PART NO:

DELTA MODEL: THA0412BN

9. P & Q CURVE:

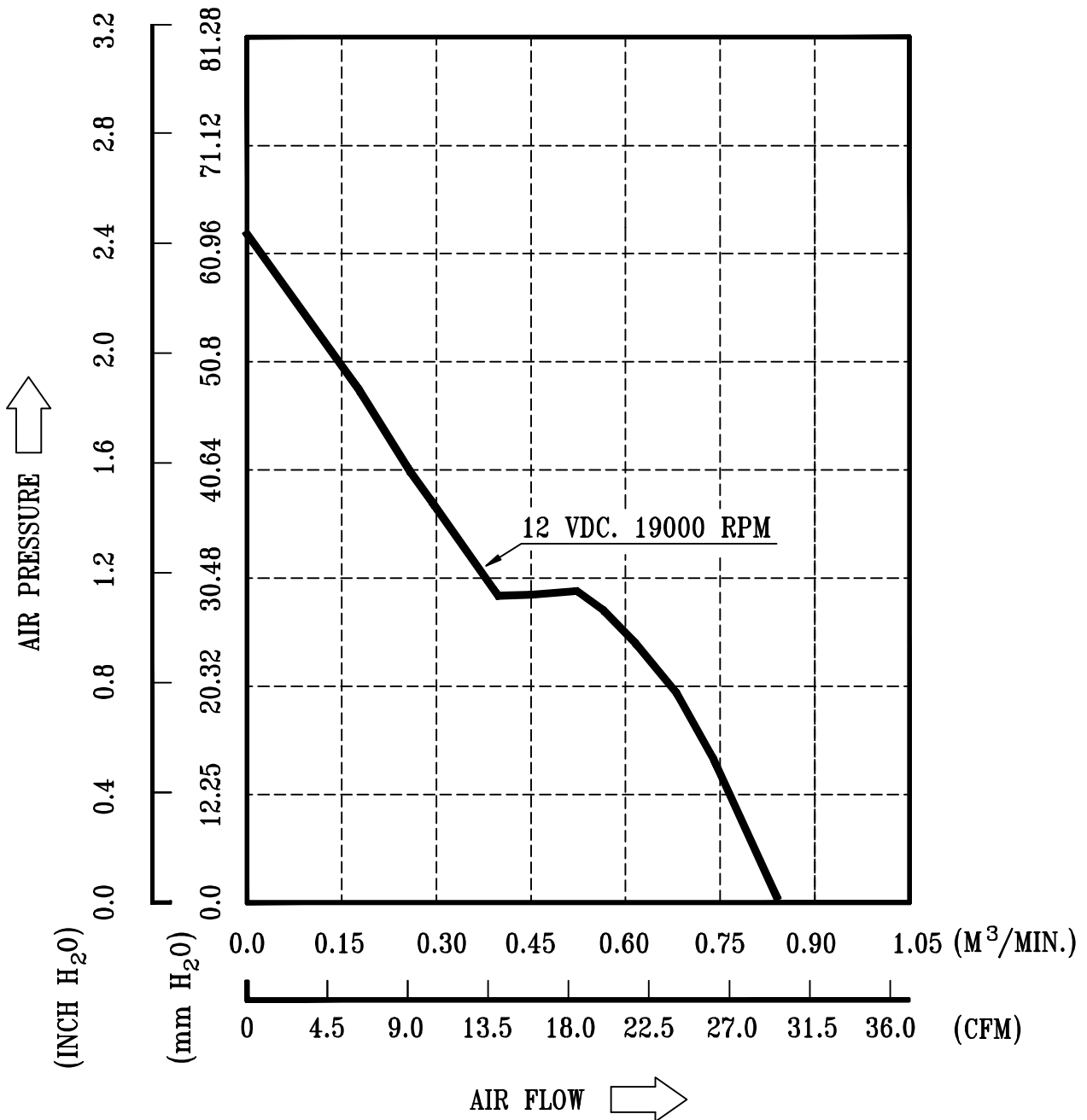

\* TEST CONDITION: INPUT VOLTAGE ----- OPERATION VOLTAGE  
TEMPERATURE ----- ROOM TEMPERATURE  
HUMIDITY ----- 65%RH

-----  
PART NO:  
-----

DELTA MODEL: THA0412BN  
-----

10. DIMENSION DRAWING:

LABEL:

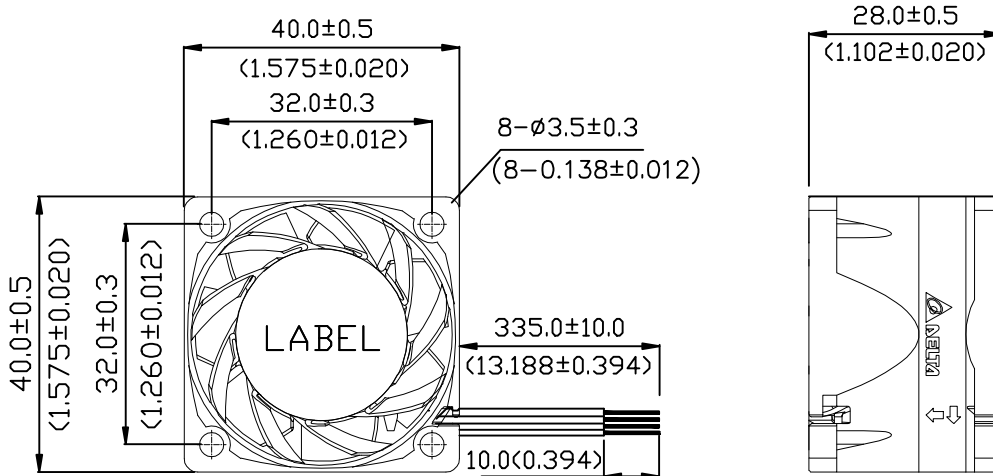
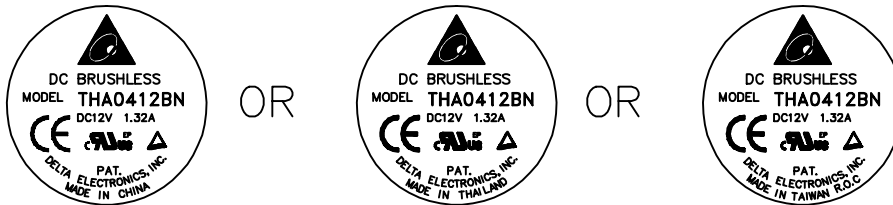

REAR VIEW

NOTE:

1. THIS PRODUCT IS RoHS COMPLIANT
2. LEAD WIRE UL 1061 -F- AWG #26  
BLACK WIRE NEGATIVE(-)  
RED WIRE POSITIVE(+)  
BLUE WIRE FREQUENCY<F00 >  
YELLOW WIRE SPEED CONTROL< PWM>

DIMENSION UNIT: MM(INCH)

-----  
PART NO:  
-----

DELTA MODEL:      THA0412BN  
-----

**11.FREQUENCY GENERATOR (FG) SIGNAL:**

**1. OUTPUT CIRCUIT - OPEN COLLECTOR MODE:**

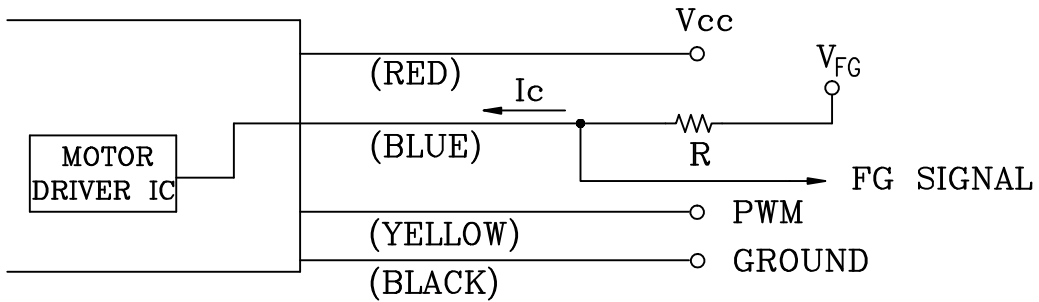

"+" LEAD WIRE & "-" LEAD WIRE.

**2. SPECIFICATION:**

$$V_{FG} = 13.2V \text{ MAX. } I_c = 5mA \text{ MAX.}$$

$$V_{CE} = 0.5V \text{ MAX. } R \geq V_{FG} / I_c$$

**3. FREQUENCY GENERATOR WAVEFORM:**

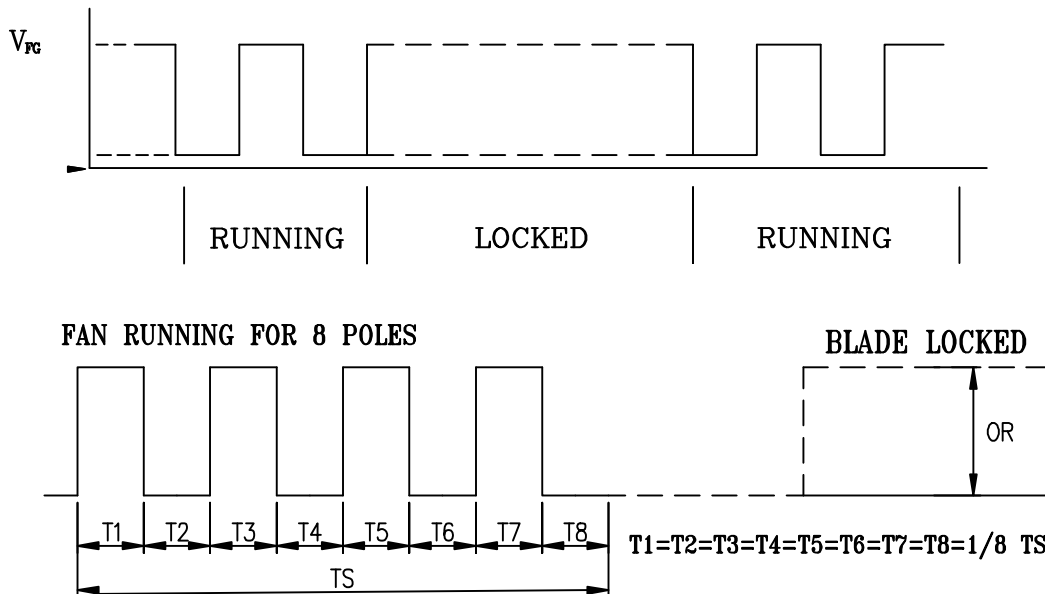

N=R.P.M

$$TS=60/N(\text{SEC})$$

\*VOLTAGE LEVEL AFTER BLADE LOCKED

\*8 POLES



-----  
PART NO:  
-----

DELTA MODEL: THA0412BN  
-----

12. PWM CONTROL SIGNAL:

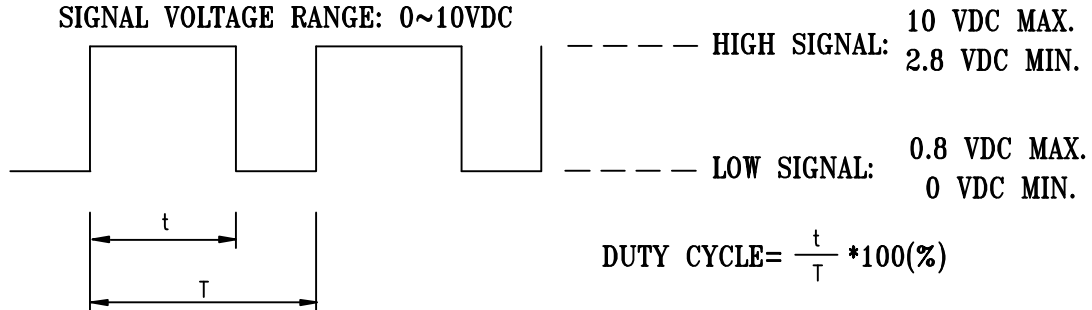

- THE PREFERRED OPERATING POINT FOR THE FAN IS 25K HZ.
- AT 100% DUTY CYCLE,THE ROTOR WILL SPIN AT MAXIMUM SPEED.
- AT 0% DUTY CYCLE,THE ROTOR WILL SPIN AT MINIMUM SPEED.
- WITH CONTROL SIGNAL LEAD DISCONNECTED,THE FAN WILL SPIN AT MAXIMUM SPEED.
- AT 25K HZ 25% DUTY CYCLE ,THE FAN WILL BE ABLE TO START FROM A DEAD STOP .

13. SPEED VS PWM CONTROL SIGNAL: (AT 12V & PWM FREQUENCY=25KHZ)

DUTY CYCLE (%)	SPEED R.P.M. (REF.)	CURRENT (A) REF.
100	19000±10%	1.10
0	0	0.02

14. PWM CONTROL LEAD WIRE INPUT IMPEDANCE:

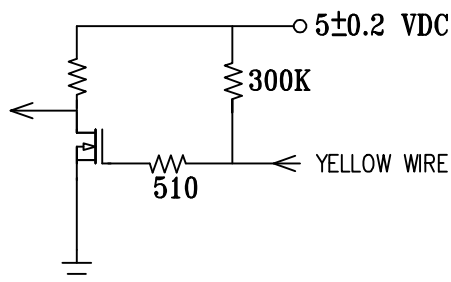



## ***Application Notice***

- 1. Delta will not guarantee the performance of the products if the application condition falls outside the parameters set forth in the specification.**
- 2. A written request should be submitted to Delta prior to approval if deviation from this specification is required.**
- 3. Please exercise caution when handling fans. Damage may be caused when pressure is applied to the impeller, if the fans are handled by the lead wires, or if the fan was hard-dropped to the production floor.**
- 4. Except as pertains to some special designs, there is no guarantee that the products will be free from any such safety problems or failures as caused by the introduction of powder, droplets of water or encroachment of insect into the hub.**
- 5. The above-mentioned conditions are representative of some unique examples and viewed as the first point of reference prior to all other information.**
- 6. It is very important to establish the correct polarity before connecting the fan to the power source. Positive (+) and Negative (-). Damage may be caused to the fans if connection is with reverse polarity, if there is no foolproof method to protect against such error specifically mentioned in this spec.**
- 7. Delta fans without special protection are not suitable where any corrosive fluids are introduced to their environment.**
- 8. Please ensure all fans are stored according to the storage temperature limits specified. Do not store fans in a high humidity environment. We highly recommend performance testing is conducted before shipping, if the fans have been stored over 6 months.**
- 9. Not all fans are provided with the Lock Rotor Protection feature. If you impair the rotation of the impeller for the fans that do not have this function, the performance of those fans will lead to failure.**
- 10. Please be cautious when mounting the fan. Incorrect mounting of fans may cause excess resonance, vibration and subsequent noise.**
- 11. It is important to consider safety when testing the fans. A suitable fan guard should be fitted to the fan to guard against any potential for personal injury.**
- 12. Except where specifically stated, all tests are carried out at room (ambient) temperature and relative humidity conditions of 25°C, 65% RH. The test value is only for fan performance itself.**
- 13. Be certain to connect an “4.7µF or greater” capacitor to the fan externally when the application calls for using multiple fans in parallel, to avoid any unstable power.**